



ANDRITZ

Annual report 2014



Contents

Key financial figures 2014
Page 2

Company profile, strategy, and vision
Page 4

2014 business year
Page 10

The ANDRITZ share
Page 12

The ANDRITZ business areas: HYDRO
Page 20

PULP & PAPER
Page 38

METALS
Page 58

SEPARATION
Page 78

USA

The acquisition of Herr-Voss Stamco Inc. significantly strengthens the service portfolio for North American customers in the metals sector.
Page 10

Austria

The challenge: long-term profitable corporate growth
Interview with the ANDRITZ Executive Board at the headquarters in Graz: is the company back on track?
Page 6

Austria

The challenge: large projects
One of the largest paper machines in Europe goes into full operation – a project of superlatives.
Page 46

Germany

The challenge: future and innovation
Cars are becoming lighter, more environmentally friendly, and safer all the time. Following the successful acquisition of Schuler, Germany, ANDRITZ is the only supplier worldwide to offer solutions for all important lightweight construction processes in the automotive sector.
Page 62

Germany

Major upgrade order in the steel segment from ThyssenKrupp Rasselstein.
Page 74

Brazil

The challenge: large projects
The largest and most modern pulp mill in the world is delivering world records with ANDRITZ technology.
Page 42

Brazil

Large order from the largest integrated pulp and paper producer in Brazil.
Page 52

France/ Brazil

ANDRITZ researchers develop a screw press that sets new standards.
Page 88





Scotland

First commercial order worldwide to supply tidal current turbines.
Page 35

Africa

Large order for the Laúca hydropower plant, Angola.
Page 37

Laos

The challenge: complex projects
One of the most complex international projects that ANDRITZ has ever handled was completed with the customer handover of the Theun-Hinboun hydropower station.
Page 24

Laos

The challenge: sustainability
Large hydropower plants can leave their mark. But, if managed correctly, their positive effects can clearly outweigh this.
Page 30

China

The challenge: growth markets
How ANDRITZ achieved market leadership as a high-tech company in China working out of the southern Chinese industrial city of Foshan.
Page 14

China

FAW Volkswagen Automotive awards Schuler one of the largest orders in the company's 175-year history.
Page 76

Indonesia

The challenge: global competition
The customer demanded the best technology at the lowest price. How ANDRITZ won against tough international competition.
Page 82



In the **2014 financial report**, you can find all important information about business development and outlook, risk management and corporate risks, research and development, share and shareholder structure, corporate governance, as well as the Supervisory Board report and the ANDRITZ GROUP's consolidated financial statements.

Global challenges

ANDRITZ is a truly global company. This is demonstrated not only by the fact that we have 250 sites in more than 40 countries throughout the world where almost 25,000 employees work every day, but also by our many international projects in which we provide our customers with state-of-the-art technologies and best services. Internationality and global presence also mean dealing with a lot of challenges. These include risks, but also opportunities in connection with the execution of projects, which involve ANDRITZ employees from many countries and numerous local suppliers and which are sometimes exposed to external factors. In this annual report, our aim is to describe the challenges and opportunities that arise from our international presence in order to give you a better picture of the global ANDRITZ GROUP.

Key financial figures

ANDRITZ GROUP

	Unit	2014	2013	2012*	2011	2010
Order intake	MEUR	6,101.0	5,611.0	4,924.4	5,706.9	4,131.9
Order backlog (as of end of period)	MEUR	7,510.6	7,388.5	6,614.8	6,683.1	5,290.9
Sales	MEUR	5,859.3	5,710.8	5,176.9	4,596.0	3,553.8
EBITDA ¹⁾	MEUR	472.0	255.2	418.6	386.2	307.3
EBITDA margin	%	8.1	4.5	8.1	8.4	8.6
EBITA ²⁾	MEUR	379.5	164.1	357.8	331.5	257.6
EBITA margin	%	6.5	2.9	6.9	7.2	7.2
Earnings Before Interest and Taxes (EBIT)	MEUR	295.7	89.8	334.5	312.7	245.5
EBIT margin	%	5.0	1.6	6.5	6.8	6.9
Earnings Before Taxes (EBT)	MEUR	299.4	80.3	330.4	321.7	247.9
Net income (including non-controlling interests)	MEUR	210.0	53.2	241.3	231.5	177.0
Fixed assets	MEUR	1,780.0	1,759.0	1,390.8	1,151.8	858.9
Current assets	MEUR	4,187.6	3,812.4	3,770.2	3,414.8	3,176.9
Total shareholders' equity ³⁾	MEUR	1,014.8	929.5	1,033.8	938.9	794.4
Provisions	MEUR	1,056.2	993.6	725.4	667.3	582.8
Liabilities	MEUR	3,896.6	3,648.3	3,401.8	2,960.4	2,658.6
Total assets	MEUR	5,967.6	5,571.4	5,161.0	4,566.6	4,035.8
Equity ratio ⁴⁾	%	17.0	16.7	20.0	20.6	19.7
Liquid funds ⁵⁾	MEUR	1,701.6	1,517.0	2,047.8	1,814.5	1,594.7
Net liquidity ⁶⁾	MEUR	1,065.1	893.1	1,285.7	1,400.6	1,177.0
Cash flow from operating activities	MEUR	342.1	93.7	346.5	433.8	704.5
Capital expenditure ⁷⁾	MEUR	106.5	111.4	109.1	77.0	68.8
Employees (as of end of period; without apprentices)	-	24,853	23,713	17,865	16,750	14,655

* Adjusted to comply with IAS 19 and IFRS 3. 1) Earnings Before Interest, Taxes, Depreciation, and Amortization 2) Earnings Before Interest, Taxes, Amortization of identifiable assets acquired in a business combination and recognized separately from goodwill at the amount of 78,038 TEUR (2013: 70,529 TEUR), and impairment of goodwill at the amount of 5,747 TEUR (2013: 3,800 TEUR) 3) Total shareholders' equity including non-controlling interests 4) Shareholders' equity/total assets 5) Cash and cash equivalents plus marketable securities plus loans against borrowers' notes 6) Liquid funds plus fair value of interest rate swaps minus financial liabilities 7) Additions to intangible assets and property, plant, and equipment. – All figures according to IFRS. Due to the utilization of automatic calculation programs, differences can arise in the addition of rounded totals and percentages. MEUR = million euros, TEUR = thousand euros. The Schuler Group was consolidated into the consolidated financial statements of the ANDRITZ GROUP as of March 1, 2013. No pro forma figures are available for the reference periods of the previous years.

Sales rises to just under 5.9 billion euros

High workload with order backlog of 7.5 billion euros

Order intake reaches a new record level of 6.1 billion euros

Earnings (EBITA), at 380 million euros, and profitability (EBITA margin), at 6.5%, increase significantly compared to the very low level of the previous year

Solid capital structure: net liquidity of 1.1 billion euros and equity ratio of 17.0%

Executive Board proposes increasing the dividend to 1.00 euro per share (2013: 0.50 euro)

ANDRITZ HYDRO

	<i>Unit</i>	2014	2013	2012	2011	2010
Order intake	MEUR	1,816.7	1,865.4	2,008.4	2,096.2	1,870.1
Order backlog (as of end of period)	MEUR	3,708.6	3,722.4	3,842.3	3,671.4	3,376.0
Sales	MEUR	1,752.3	1,804.8	1,836.8	1,772.9	1,579.2
EBITDA	MEUR	177.2	176.8	182.4	174.3	139.9
EBITDA margin	%	10.1	9.8	9.9	9.8	8.9
EBITA	MEUR	144.8	146.9	153.2	147.7	118.0
EBITA margin	%	8.3	8.1	8.3	8.3	7.5
Capital expenditure	MEUR	39.4	44.5	56.7	44.3	41.5
Employees (as of end of period; without apprentices)	-	8,339	7,445	7,469	7,285	6,530

ANDRITZ PULP & PAPER

	<i>Unit</i>	2014	2013	2012	2011	2010
Order intake	MEUR	1,995.7	1,907.7	1,962.4	2,694.1	1,415.5
Order backlog (as of end of period)	MEUR	1,875.4	1,885.6	2,018.1	2,230.0	1,107.3
Sales	MEUR	1,969.3	2,005.3	2,282.2	1,884.9	1,129.8
EBITDA	MEUR	127.6	-11.5	156.2	138.1	99.9
EBITDA margin	%	6.5	-0.6	6.8	7.3	8.8
EBITA	MEUR	102.9	-35.7	134.6	120.4	82.2
EBITA margin	%	5.2	-1.8	5.9	6.4	7.3
Capital expenditure	MEUR	28.1	26.0	36.4	22.5	18.4
Employees (as of end of period; without apprentices)	-	7,236	7,136	6,774	6,208	5,046

ANDRITZ METALS

	<i>Unit</i>	2014	2013	2012	2011	2010
Order intake	MEUR	1,692.8	1,233.8	324.2	318.6	302.7
Order backlog (as of end of period)	MEUR	1,566.1	1,427.6	451.4	465.1	521.0
Sales	MEUR	1,550.4	1,311.0	404.7	372.7	340.2
EBITDA	MEUR	134.0	76.6	28.0	21.5	21.2
EBITDA margin	%	8.6	5.8	6.9	5.8	6.2
EBITA	MEUR	110.2	53.5	25.1	19.4	18.4
EBITA margin	%	7.1	4.1	6.2	5.2	5.4
Capital expenditure	MEUR	27.9	32.7	2.6	1.8	1.9
Employees (as of end of period; without apprentices)	-	6,432	6,300	1,129	945	937

The Schuler Group was consolidated into the consolidated financial statements of the ANDRITZ GROUP as of March 1, 2013 and is allocated to the METALS business area. No pro forma figures are available for the reference periods of the previous years.

ANDRITZ SEPARATION

	<i>Unit</i>	2014	2013	2012	2011	2010
Order intake	MEUR	595.8	604.1	629.4	598.0	543.6
Order backlog (as of end of period)	MEUR	360.5	352.9	303.0	316.6	286.6
Sales	MEUR	587.3	589.7	653.2	565.5	504.6
EBITDA	MEUR	33.2	13.3	52.0	52.3	46.3
EBITDA margin	%	5.7	2.3	8.0	9.2	9.2
EBITA	MEUR	21.6	-0.6	44.9	44.0	39.0
EBITA margin	%	3.7	-0.1	6.9	7.8	7.7
Capital expenditure	MEUR	11.1	8.2	13.4	8.4	5.5
Employees (as of end of period; without apprentices)	-	2,846	2,832	2,493	2,312	2,143

The challenge: global market leadership

The ANDRITZ goals

Company profile: worldwide presence

ANDRITZ is a globally leading supplier of plants, equipment, and services for hydropower stations, the pulp and paper industry, the metalworking and steel industries, and for solid/liquid separation in the municipal and industrial sectors. The publicly listed technology Group is headquartered in Graz, Austria, and has a staff of almost 25,000 employees. ANDRITZ operates over 250 sites worldwide.

Strategy: global market leadership

1. Extend position in Europe and North America, make use of opportunities in South America and Asia

All four ANDRITZ business areas serve markets with long-term and sustained growth potential. Within these markets, the Group focuses on rapidly growing segments,

for example the supply of plants and equipment to generate renewable energy from hydropower or biomass. In terms of global regions, this means that the ANDRITZ GROUP is extending its existing position in Europe and North America and making use of the growth and sales opportunities in the emerging markets of South America and Asia.

2. Global and local customer proximity

The ANDRITZ GROUP is globally present. Customers benefit from this network through the global ANDRITZ know-how on the one hand and the local proximity of ANDRITZ on the other hand. Based on this mixture of global and local customer proximity, the Group supports customers in achieving their goals in terms of productivity, profitability, and sustainability.

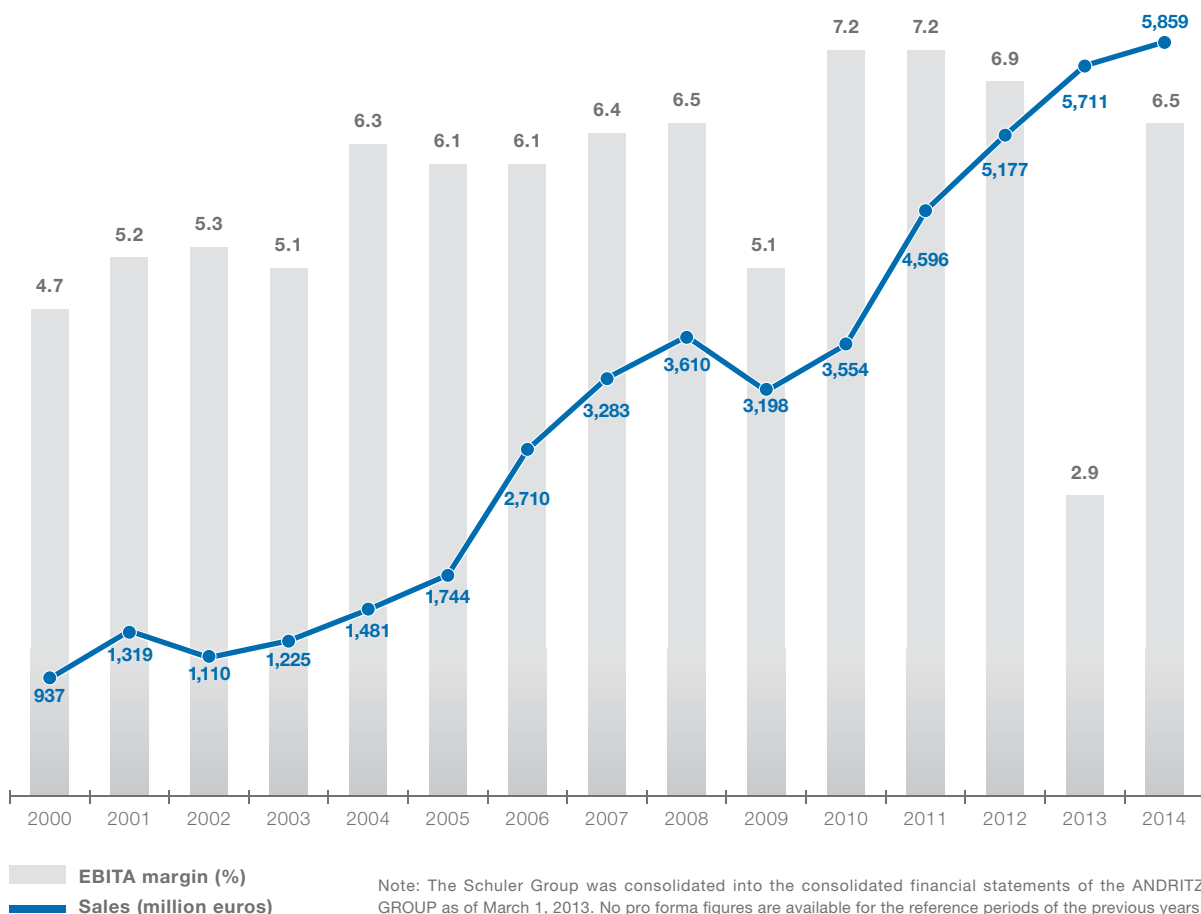

3. Technological and cost leadership

ANDRITZ relies on technological and cost leadership in order to safeguard its market position and make use of opportunities for growth. As part of its organic expansion, ANDRITZ invests an average of 3% of its annual sales in research and development in order to be the preferred supplier in terms of technology and costs. The main priority is to develop customized technologies that enhance the productivity of customers' plants, minimize operating costs, and maximize energy efficiency and environmental protection. In addition, ANDRITZ is constantly seeking to improve internal cost structures through operational and organizational measures. These include regional and logistical optimization of manufacturing capacities, pooling of procurement activities, as well as cost discipline both in operating units and central functions across the Group. ANDRITZ also aims

to continue its growth externally and is looking for companies that complement the existing product and service portfolio. The goal is to be a single-source supplier with full-line capabilities in all business areas.

Vision: market leadership in sustainable technologies

The ANDRITZ GROUP has the goal of achieving market leadership in all of the markets it serves and of strengthening and extending its current top position on the market. At the same time, the Group aims to continue its long-term, profitable growth. ANDRITZ intends to achieve this goal by offering the best technologies available on the market and providing products and services that create sustained economic, social, and ecological benefits for customers, for society, and for the environment.

Long-term profitability

The ANDRITZ GROUP has been pursuing a strategy of long-term, profitable growth for many years. Organic growth, complementary acquisitions, and a solid balance sheet structure are the fundamental cornerstones to reach the financial targets set. ANDRITZ has been able to increase its sales by an annual average of about 14% since 2000 and step-by-step its profitability (EBITA margin) at the same time. Whereas the EBITA margin averaged 5.3% from 2000 to 2004, it rose to 6.0% between 2005 and 2009. The goal set in 2010 of increasing the EBITA margin to 7% was achieved in 2010, 2011, and 2012. However, due to provisions and expenses for cost overruns in connection with deliveries for a pulp mill in South America, there was a significant decline in profitability in 2013. In 2014, a significant improvement in earnings and profitability was achieved. The medium-term goal for the coming years is to increase the EBITA margin to 8% in step with the planned sales growth.

EBITA margin 2000-2004: 5.3%



EBITA margin 2005-2009: 6.0%



*Profitability goal of ANDRITZ: 7-8%
(EBITA margin of 7% over the cycle and increase up
to 8% in step with the planned growth in sales)*

The challenge: long-term profitable growth

“We target a further increase in earnings in 2015”

After disappointing earnings in 2013, ANDRITZ saw a rise in profits during the 2014 business year. Are the company’s earnings back on track?

Wolfgang Leitner: Although our profits have improved considerably when compared with the very low figure in 2013, which was primarily caused by cost overruns on a pulp project in South America, in 2014 we still failed to meet our medium-term profitability goal of an EBITA margin of seven percent. We still had some projects with low margins in our order books, which affected sales and net income in 2014. However, overall we were able to increase our earnings from quarter to quarter and ultimately achieved an EBITA margin of 6.5 percent for the year as a whole. We target a further increase in earnings in 2015.

What measures will you take to improve the earnings?

Wolfgang Leitner: As in previous years, we are working continuously to simplify our organizational structure and to improve our processes in the areas of project planning, order processing, and risk management. Cost

transparency plays a key role in this respect. It will enable us to identify potential large-scale cost variances at an early stage and to take countermeasures on time. Cost discipline in all areas of the company is also one of our top priorities in 2015. We are constantly monitoring all business areas in terms of profitability and growth opportunities. Our goal is to continue our long-term, profitable growth by means of organic expansion and acquisitions.

Joachim Schönbeck, you joined the Executive Board of the ANDRITZ GROUP in October 2014 and you are responsible for the Capital Systems segment in the PULP & PAPER business area. This segment includes the large contract for the Montes del Plata pulp mill in Uruguay, which was the main cause for the sharp fall in earnings in 2013. ANDRITZ was still heavily involved in this contract in 2014. Has it now been completed?

Joachim Schönbeck: The Montes del Plata project has had no negative effects on our earnings since the second quarter of 2014. In the meantime, the customer has started industrial operations with good results. At the



Wolfgang Leitner

President and CEO with responsibility for central Group functions. Joined ANDRITZ in 1987, President and CEO since 1994.

Wolfgang Leitner on strategic objectives:

“Our goal is to continue our long-term, profitable growth by means of organic expansion and acquisitions.”



Joachim Schönbeck

Responsible for the PULP & PAPER business area (Capital Systems) and Group Quality and Safety Management. Joined ANDRITZ in 2014. From April 1, 2015, Joachim Schönbeck will take over the METALS business area from Friedrich Papst, who is retiring.

moment, we are carrying out acceptance tests and expect the commercial project finalization before the end of this year.

You are also responsible for Groupwide quality management. How important is this area for the company's success?

Joachim Schönbeck: Many years of experience in plant engineering and construction have taught me that quality is crucial to sustainable business success. Quality management goes far beyond simply the quality of the product and includes, in particular, organizing all our business processes efficiently and transparently, which allows everyone involved in projects to work together without problems and to learn from mistakes. Particularly in the case of large projects, like those in the pulp segment, well-organized processes are essential. Therefore, I believe that quality management lies at the heart of the organization and is a key requirement for corporate success.

Joachim Schönbeck on requirements for success:

"I believe that quality management lies at the heart of the organization and is a key requirement for corporate success."

The METALS business area saw good growth in 2014, with a considerable increase in new orders, a rise in sales, and much better earnings than in 2013. What contribution to this growth came from press manufacturer Schuler and what was the performance of the rest of the METALS business area like?

Friedrich Papst: Since the acquisition in February 2013, Schuler has developed above our expectations. During the 2014 business year, the company continued the measures it started in 2013 to simplify its organizational structure and has now successfully completed them. In addition, Schuler has in place an ambitious program to improve its competitiveness. One of its strategic goals is to enhance the value chain by increasing its presence in the main markets, such as China. An increased focus on in-house manufacturing of core components is also intended to make the company more competitive. Schuler aims to maintain its technological leadership in the automotive industry and, if possible, to improve its position even further. It also has plans for growth outside the automotive sector, for example, in areas such as presses for deodorant, hairspray, and drinks containers. The remainder of the METALS area also performed very well and developed above expectations. Order intake in the aluminum segment, in particular, was very good. We intend to increase our market share in this segment and also to continue to grow by expanding our service business.

The SEPARATION business area has had a difficult time in terms of earnings. Its EBITA was negative in 2013, but in 2014 it was back in the black, although the improvement was only slight. Have the difficulties which led to the poor earnings been resolved?

Humbert Köfler: We have now solved the problems caused by the market launch of some products in China and the related outsourcing of production. In addition, we have significantly simplified the organizational structure of the business area and focused it more closely on the require-

Friedrich Papst on the press manufacturer Schuler:

"Since the acquisition in February 2013, Schuler has developed above our expectations."



Friedrich Papst

Responsible for the METALS business area, the pumps division (HYDRO business area), animal feed/biomass pelleting (SEPARATION business area), and Group Manufacturing and Procurement Management. Joined ANDRITZ in 1979. On March 31, 2015, Friedrich Papst will retire after being a member of the Executive Board for more than 16 years.

ments of the market. The new structure puts us in a good position to improve our business development. Our aim is to grow by making the best possible use of local sales organizations and by expanding our service business. And we are also constantly on the lookout for potential acquisitions.

The HYDRO area saw good profitability once again in 2014, but order intake and sales were slightly lower than in the previous year. What potential or opportunities are open to ANDRITZ in the hydropower market?

Wolfgang Semper: The global market for hydropower equipment has shrunk in recent years from around 7 to 5.5 billion euros. Because the market as a whole is now smaller, we have been facing an extremely challenging and competitive environment. Nevertheless, our profitability is good and our order intake remains at a high level. In the next few years, we are expecting some new, large projects in South America and Africa. We also believe that there is a great deal of potential in modernizing existing plants, because more than half of the installed hydropower capacity is now over 30 years old. There are also good opportunities for growth in the small-scale hydropower segment. Because of the low investment costs, this type of electricity generation is very attractive, particularly in emerging countries with a growing energy demand. We will also continue to expand our service business. In the field of innovative technologies for generating electricity from renewable energy, we had a significant success by winning the world's first commercial contract for tidal current turbines for a tidal energy farm in Scotland.

The 2014 annual report focuses on global challenges. How does ANDRITZ see the interaction of global versus local?

Wolfgang Leitner: ANDRITZ is a truly global company. We have a local presence in all the major markets, our own production facilities, and long-term business relationships with international customers and suppliers. Our Chinese subsidiary is an excellent example of the market success that can be achieved with a highly effective local organization. By understanding the market and responding quickly to customers' requirements, ANDRITZ has become the Chinese market leader in some product segments within just a few years and has also strengthened the position of some of its divisions on a global level. The ANDRITZ GROUP now has almost 25,000 employees working at more than 250 sites all over the world and around 40 percent of them are outside Europe. With our local presence in around 40 countries, our aim is to be close to our customers and to make use of attractive local opportunities for production and procurement. More than one third of our manufacturing capacity is in emerging



Wolfgang Semper

Responsible for the HYDRO business area and Group Automation. Joined ANDRITZ in 2006.

markets and our plan is to increase that further. This will to a certain extent enable us to manufacture products in the location where the customer's order is being implemented, and will also make us more competitive in terms of price on a global level. This is an important prerequisite for long-term success in our highly competitive industry. At the

Wolfgang Semper on the global hydropower market:
"In the next few years, we are expecting some new, large projects in South America and Africa."

same time, we also make important contributions towards economic and social development in these countries.

Wolfgang Semper: Another important factor in the context of global versus local is the fact that our global sites are pooling their skills and strengths so that they can work together efficiently on large projects. In the HYDRO business area, for example, we completed a contract in 2014 that involved nine of our sites all over the world.

Humbert Köfler: In the PULP & PAPER and SEPARATION business areas, we have a large service business. Around one third of sales in the PULP & PAPER area come from services. In the case of SEPARATION, the figure is more than 40 percent. Proximity to the customer and a local presence are particularly important in the service business. We must give our customers ongoing support and, if necessary, be able to respond quickly to urgent issues. To do this, we need highly qualified local staff and a well-established network of service workshops, like the one we have built up over the last few years.

Humbert Köfler on the difficulties in the SEPARATION business area:

"We have now solved the problems caused by the market launch of some products in China and the related outsourcing of production."



Humbert Köfler

Responsible for the PULP & PAPER (Service & Units) and SEPARATION business areas. Joined ANDRITZ in 1987.

A solid business year

Sales of the ANDRITZ GROUP amounted to 5,859.3 million euros (MEUR) in the 2014 business year. This slight increase of 2.6% compared to 2013 (5,710.8 MEUR) is attributable to the Schuler Group, which contributed 1,178.4 MEUR and was only included for 10 months in the Group's 2013 financial statements (first-time consolidation of Schuler: March 1, 2013; sales contribution 2013: 966.6 MEUR).

The order intake rose by 8.7% to 6,101.0 MEUR (2013: 5,611.0 MEUR). The Schuler Group contributed 1,193.7 MEUR (2013: 868.4 MEUR).

As of December 31, 2014, the order backlog amounted to 7,510.6 MEUR (+1.7% compared to the end of last year: 7,388.5 MEUR).

EBITA increased significantly to 379.5 MEUR (+131.3% versus 2013: 164.1 MEUR) and the EBITA margin rose to 6.5% (2013: 2.9%). Earnings were thus considerably higher compared to the very low reference figure of last year, which was negatively impacted by additional costs in the PULP & PAPER business area (for a pulp mill project in South America), METALS business area (restructuring of the Schuler Group), and SEPARATION business area (market launch of a new product series and restructuring measures).

The net income amounted to 210.0 MEUR (+294.7% versus 2013: 53.2 MEUR).

The net worth position and capital structure as of the end of 2014 remained solid. Total assets amounted to 5,967.6 MEUR (December 31, 2013: 5,571.4 MEUR). The equity ratio reached 17.0% (December 31, 2013: 16.7%). Liquid funds reached 1,701.6 MEUR (December 31, 2013: 1,517.0 MEUR) and net liquidity amounted to 1,065.1 MEUR (December 31, 2013: 893.1 MEUR).

Contribution by business areas to the total sales of the ANDRITZ GROUP in 2014 (2013)

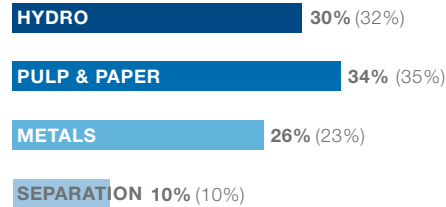

Contribution by business areas to the total order backlog of the ANDRITZ GROUP in 2014 (2013)

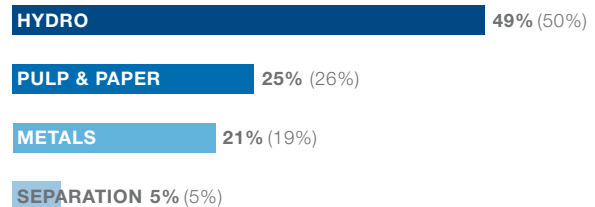

ANDRITZ METALS strengthens service portfolio

By acquiring Herr-Voss Stamco Inc., USA, ANDRITZ has enlarged its service and product offerings for North American customers in the metals sector. ANDRITZ Herr-Voss Stamco is one of the leading suppliers of coil and sheet metal processing solutions for both ferrous and non-ferrous applications worldwide and is offering a comprehensive service portfolio for the metals processing industry.

ANDRITZ



Order intake by region 2014 (2013)

Order intake amounted to 6,101.0 MEUR in 2014 (2013: 5,611.0 MEUR)

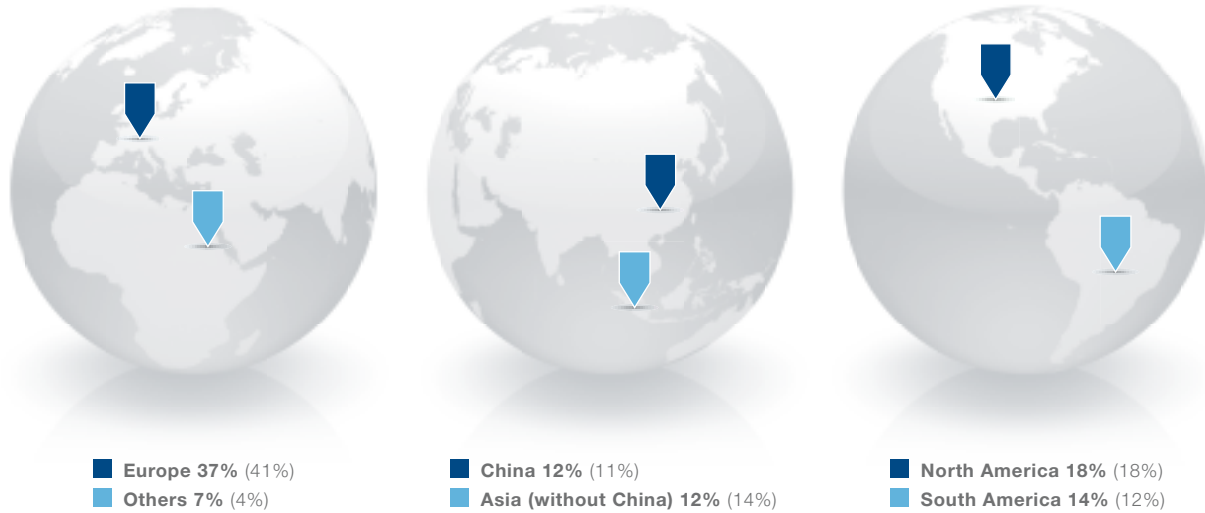

Employees by region as of end of 2014 (2013)

ANDRITZ had a staff of 24,853 employees in 2014 (2013: 23,713 employees)

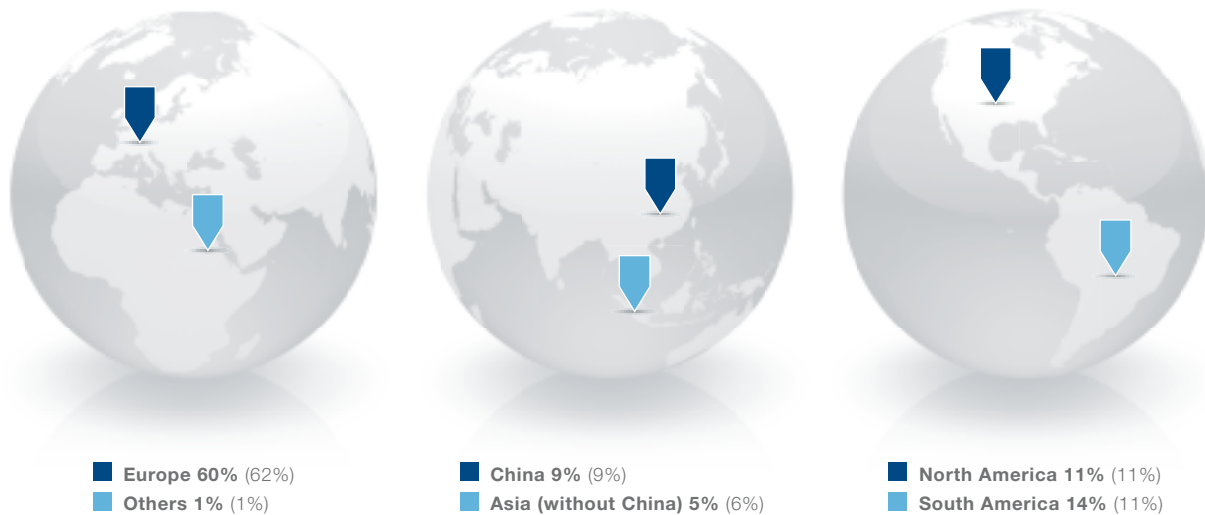

The ANDRITZ share

In 2014, the development on the international financial markets continued to be impacted by the uncertain general economic conditions and resulting high volatility. In this environment, the ANDRITZ share price remained stable in 2014 (+/-0%), while the ATX, the leading share index on the Vienna Stock Exchange, decreased by 14.7%. The highest closing price of the ANDRITZ share was 47.58 euros (March 7, 2014), while the lowest was 37.00 euros (October 15, 2014). The average daily trading volume of the ANDRITZ share (double count, as published by the Vienna Stock Exchange) was 305,027 shares (2013: 316,787 shares). The highest daily trading volume was noted on September 19, 2014 with 1,820,158 shares and the lowest trading volume on August 25, 2014 with 83,306 shares.

Long-term dividend policy

ANDRITZ pursues a dividend policy oriented towards continuity. Depending on business development, ANDRITZ aims to pay out around 50% of earnings per share for the respective business year to the shareholders and to increase this payout ratio step-by-step over the next few years to around 60%.

Well-balanced shareholder structure

ANDRITZ has a very stable and well-balanced shareholder structure. 25% plus one share are owned by SASR Achtundfünfzigste Beteiligungsverwaltung GmbH, whose Managing Director is Wolfgang Leitner, President and CEO of ANDRITZ AG. The free float is just under 75%. The larger shareholders include The Capital Group Companies, Inc., FMR LLC, and Certus Beteiligungs-GmbH (see table showing shareholder structure). The remaining free float is held by national and international

institutional investors and private investors. The majority of the institutional investors come from the UK, the USA, Austria, and Germany, and most of the private investors are from Austria and Germany.

Transparent information policy

ANDRITZ focuses on continuous, transparent communication. In 2014, meetings with international institutional investors and financial analysts were held in Amsterdam, Berlin, Boston, Brussels, Chicago, Cologne, Düsseldorf, Frankfurt, Geneva, Hong Kong, London, Los Angeles, Melbourne, Montreal, Munich, New York, Paris, Salt Lake City, San Francisco, Singapore, Sydney, Tokyo, Toronto, Warsaw, Vienna, Zürich, and Züri. ANDRITZ gave presentations for private investors at various roadshows in Austria.

At the 2014 Capital Market Day, attended by 20 national and international financial analysts, the Executive Board provided information on current developments and expectations for the business areas and on the goals of the ANDRITZ GROUP in the medium to long term.

For the fifth year in succession, the ANDRITZ annual report received prizes at the world's premier and largest annual report competition, the ARC awards in New York. Among the prizes won for the 2013 annual report was the Gold Award for the quality of the text.

Broad coverage

There are currently 13 international banks and investment houses publishing analysis reports on ANDRITZ at regular intervals: Baader Bank, Berenberg Bank, Commerzbank, Deutsche Bank, Erste Bank, Goldman Sachs International, Hauck & Aufhäuser, HSBC Trinkaus, J.P. Morgan, Kepler Cheuvreux, Raiffeisen Centrobank, UBS, and Warburg Research.

Shareholder structure (as of December 31, 2014)

~ 75% free float	Thereof 9.23% The Capital Group Companies, Inc., 5.47% FMR LLC (Fidelity Management & Research), and 3.99% Certus Beteiligungs-GmbH
25% plus one share	SASR Achtundfünfzigste Beteiligungsverwaltung GmbH

Financial calendar 2015

March 5	Results for the 2014 business year
March 26	Annual General Meeting
March 31	Ex-dividend
April 2	Dividend payment
May 6	Results for Q1 2015
August 7	Results for H1 2015
November 6	Results for Q1-Q3 2015

Basic data of the ANDRITZ share

ISIN code	AT0000730007
First listing day	June 25, 2001
Types of share	No-par value shares, bearer shares
Total number of shares	104 million
Authorized capital	None
Free float	About 75%
Stock exchange	Vienna (Prime Market)
Ticker symbols	Reuters: ANDR.VI; Bloomberg: ANDR, AV
Stock exchange indices	ATX, ATX five, ATX Global Players, ATX Prime, WBI

Relative share price performance of the ANDRITZ share versus the ATX since the IPO

Share price at IPO:

2.63 euros

Closing price at year end 2014:

45.69 euros

Performance since the IPO

(June 2001 to end of 2014):

ANDRITZ: +1,637% / ATX: +75%

Performance 2014:

ANDRITZ: +/-0% / ATX: -14.7%

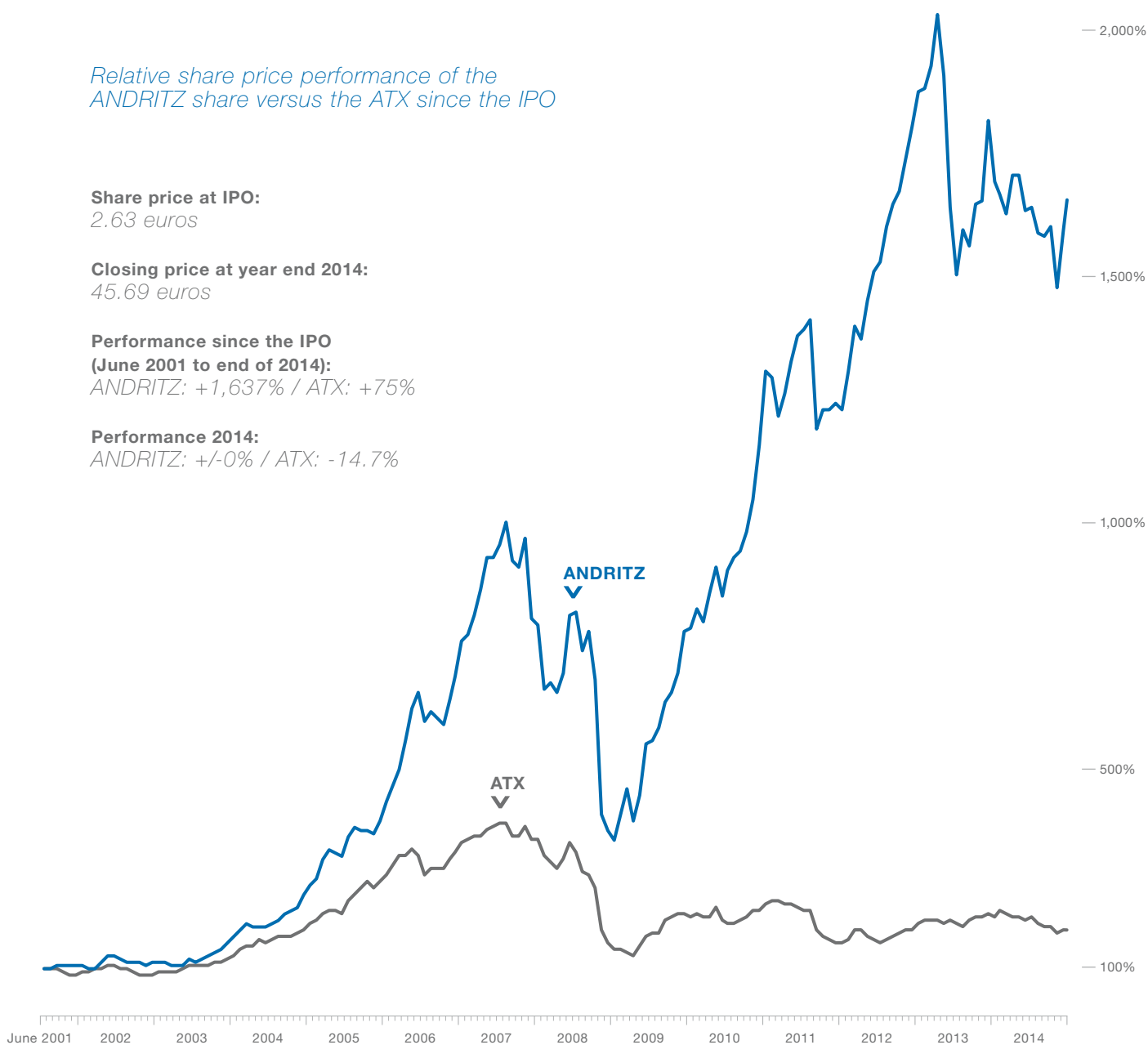

Key figures of the ANDRITZ share

	Unit	2014	2013	2012	2011	2010
Earnings per share	EUR	2.04	0.64	2.35	2.25	1.74
Dividend per share	EUR	1.00 ¹⁾	0.50	1.20	1.10	0.85
Payout ratio	%	49.0	78.1	51.1	49.0	48.9
Equity attributable to shareholders per share	EUR	9.63	8.70	9.76	8.75	7.34
Highest closing price	EUR	47.58	54.94	50.00	37.75	34.46
Lowest closing price	EUR	37.00	37.93	32.83	27.41	19.75
Closing price at end of year	EUR	45.69	45.59	48.54	32.05	34.40
Market capitalization (as of end of period)	MEUR	4,751.8	4,741.4	5,048.2	3,333.2	3,577.1
Performance	%	0.0	-9.4	+47.9	-7.6	+67.8
ATX weighting (as of end of period)	%	11.6479	9.5082	10.6128	9.2705	7.3211
Average daily number of shares traded ²⁾	Share unit	305,027	316,787	345,754	568,138	461,546

Source: Vienna Stock Exchange 1) Proposal to the Annual General Meeting 2) Double count, as published by the Vienna Stock Exchange

„Der Kunde ist in
China König,
und so müssen wir ihn behandeln:
**Zusagen auf den Punkt
genau einhalten und seine
Erwartungen
übertreffen!“**



Gottfried Schmölzer, President of ANDRITZ China until 2014:
"In China, the customer is king, and that is exactly how we have to treat him: fulfilling our commitments to the letter and exceeding customers' expectations wherever possible!"



Market leader in the Middle Kingdom

The challenge: China

In 2002, ANDRITZ got off to a flying start in China with its own subsidiary. Since then, sales have risen to almost 400 million euros and the number of employees has increased to around 1,600 – 7% of the Group's total staff. Today, ANDRITZ is one of the market leaders in China in some product segments. This strong presence in China has made a substantial contribution towards the success of the ANDRITZ GROUP worldwide.

The joint venture that started with the Chinese partner Kenflo in the 1990s to produce and sell stock pumps locally for the pulp and paper industry laid the foundation for establishing an ANDRITZ subsidiary in China. The joint venture was managed by an ANDRITZ employee with many years of experience who had worked on assignments all over the world: Gottfried Schmölzer from Austria. Within just a few years, he led ANDRITZ-Kenflo to become the market leader for stock pumps in China.

Rapid growth

As a result of this success, other ANDRITZ GROUP divisions soon pushed to China as well. Hence, the wholly owned subsidiary ANDRITZ Technologies Ltd., now ANDRITZ (China) Ltd., was established in 2002, and the first production facilities were set up in 2003 in the industrial city of Foshan, Guangdong Province, in southern China. Today, ANDRITZ China is manufacturing high-grade components for all four business areas in production facilities covering 50,000 square meters.

Rapid progress was made on the Chinese market. In the meantime, ANDRITZ China has supplied more than

50,000 stock pumps, 1,000 centrifuges, 2,000 pressure screens, and 1,000 refiners – primarily for customers in China. ANDRITZ not only leads the market for stock pumps in China, but also for water supply pumps, stock preparation systems for the pulp and paper industry, and for tissue machines.

All business areas under one roof

The METALS business area set up a team in Foshan in 2005, and ANDRITZ AUTOMATION joined them one year later. In 2009, the HYDRO business area's activities in China were incorporated, and the first Francis runner was produced in Foshan just one year later. The Schuler Group, which became a member of the ANDRITZ GROUP in 2013, has manufacturing locations in Dalian and Tianjin.

After twelve years at the head of ANDRITZ China and more than 40 years of service for ANDRITZ, 64-year-old Gottfried Schmölzer handed over management of the company in 2014. His successor, Thomas Schmitz (52) from Germany, intends to continue Gottfried Schmölzer's work, as well as consolidating and extending market and cost leadership in China.

“We are a high-tech company in China today”

Friedrich Papst and Gottfried Schmölzer, the architects of ANDRITZ's success in China, talk about the company's strategy and rapid development in China, about changing customer requirements, and why its strong local presence in China has also supported ANDRITZ globally.

What strategy did ANDRITZ follow on the way to China?

Friedrich Papst: We recognized the potential of the Chinese market at a very early stage and wanted to open up this market by having a local presence. In hindsight, we can say that our strategy of starting on a small scale with a joint venture and using it to extend our presence continuously proved to be the right choice. We have never lost money in China – unlike some of our competitors.

Over the years, we have also built up a pool of qualified Chinese suppliers, thus opening up the Chinese procurement market for the global ANDRITZ organization.

Why was Foshan chosen as the headquarters?

Papst: We chose Foshan because we found a suitable joint venture partner there and because the Pearl River Delta is one of the centers of the Chinese pulp and paper industry and generally a very strong economic region with excellent infrastructure. Today, ANDRITZ is one of the most important companies in Foshan – an important employer, taxpayer, and provider of know-how.

Mr. Schmölzer, you went to China for ANDRITZ in the 1990s to build up a local presence there. What was it like when you first went there?

China in the 1990s cannot be compared with China today. The country developed with enormous speed, especially between 2000 and 2005. When I first went to China, there were just a few vehicles owned by state officials and millions of bicycles in the streets. Today, there are millions of private cars around. The two-lane



ANDRITZ locations in China

- 1 北京 / Beijing
Chaoyang District
Haidian District
Xicheng District
- 2 天津 / Tianjin
Hexi District
- 3 大连 / Dalian
Ganjingzi District
- 4 成都 / Chengdu
Qingbaijiang District
- 5 无锡 / Wuxi
Wuxi New District
- 6 上海 / Shanghai
Dalian Road
Chengdu Road
Songjiang District
Zhabei District
- 7 杭州 / Hangzhou
Xiaoshan District
- 8 佛山 / Foshan
Sanshui District
Chan Cheng District

ANDRITZ is one of the most important companies in Foshan – an important employer, taxpayer, and provider of know-how.



roads have been replaced at breathtaking speed by up to twelve-lane highways. High-speed trains connect the cities, numerous large airports have appeared out of thin air – and many of them have already reached their capacity limits today.

How did ANDRITZ develop over this period?

Gottfried Schmölzer: We began on a small scale in China – with a single product, an old office, a rented workshop, a handful of employees, and a Chinese partner, the pump manufacturer Kenflo. One of the biggest challenges in the beginning was convincing customers that we were able to manufacture high-quality products in China. At that time, local customers considered Chinese goods to be of inferior quality. That is why they preferred to buy imported products. I was doing the rounds from one customer to the next with a small pump impeller to give a kind of hands-on presentation of a locally manufactured ANDRITZ product and clearly illustrate the difference between our competitors and us. This is how we managed to convince customers of the quality of our products. Meanwhile, we have sold more than 50,000 stock pumps for the pulp and paper industry and are undisputed market leaders in China, with a 70 percent market share. In addition, we contributed towards ANDRITZ stock pumps rising from a weak position globally to become the number two in the world. Strong local presence in China also enabled ANDRITZ to advance at global level.

Papst: Similar positive effects of business with China also emerged for stock preparation and tissue machines. We were able to increase our sales volume significantly, which helped us to improve successively in manufacturing, reduce our prices, and as a result be more competitive and successful worldwide.

Schmölzer: In addition to extending our manufacturing capacities, we have also extended our development and engineering competences. We are a high-tech company in China today. This status not only enhances

our reputation among Chinese customers, but also brings important tax advantages. As a so-called Guangdong Provincial High & New Tech Enterprise, we pay only 15 percent in corporate income tax instead of 25 percent.

What developments were there on the customer side?

Schmölzer: Customers also changed a great deal during this period. Whereas demands were still fairly low in the 1990s, customers in China today know exactly what they want and which technologies are available worldwide. They set very high standards and aspire to leading positions on the world market. Only ten years ago, there was not one Chinese company among the twenty largest companies in the world, and today there are two among the top five.

Papst: In future, we should expect not only growth from China, but also more and more innovations. The level of education is rising – the number of university graduates in China increased by five times between 2000 and 2010, and the number of universities doubled. As the level of education rises, so does the innovation potential in this population of 1.3 billion.



Friedrich Papst has been a member of the ANDRITZ Executive Board since 1998 and was Chairman of the Board of Directors of ANDRITZ China from 2002 to 2013: "In future, we should expect not only growth from China, but also more and more innovations."



Gottfried Schmölzer has worked for ANDRITZ since 1973 and headed the production locations in the USA and Canada before starting to build up ANDRITZ's local presence in China in 1997, which he managed from 2002 to 2014: "We began on a small scale in China – with a single product, an old office, a rented workshop, a handful of employees, and a Chinese partner."

What were the most important factors in ANDRITZ's rapid and successful development in China?

Papst: The local management in China always acted promptly and decisively. We kept the coordination process and reporting channels short and simple, enabling a prompt reaction to opportunities and changes. In a country like China, where things develop incredibly fast, this is tremendously important. Coordination between the local management and the management in Austria also functioned well, and the excellent cooperation between the teams in China and the product managers in the global divisions was equally important. In addition, we always ensured that the quality of the products and processes in China came up to the worldwide ANDRITZ standard.

Schmölzer: Our highly motivated local staff play a particularly important role. We offer our employees the opportunity to develop further – by making their own decisions in daily work situations or offering various training programs. In addition, we invest a great deal in health care and pension schemes, as well as in occupational health and safety. The low employee turnover is proof that we are right at the cutting edge compared to other companies. Our employees appreciate the efforts we make, and this in turn has an impact on the company's performance. And our employees have always concentrated on the customers' needs. In China, the customer is king, and that is exactly how we have to treat him: fulfilling our commitments to the letter and exceeding customers' expectations wherever possible!

Gabriele Weninger, Austria



***Pearl River Delta: 180 kilometers
of concentrated economic power***

In choosing its location, ANDRITZ favored the Pearl River Delta. The company found a suitable joint venture partner here in the 1990s, and this strong economic region has excellent infrastructure, as well as being the center of the Chinese pulp and paper industry. The area through which the 180 kilometer long Pearl River flows is considered one of the most active economic regions in China, with the special economic zones Shenzhen and Zhuhai as well as the mega-cities Guangzhou (photo), Foshan, and Dongguan, and the special administrative regions Hong Kong and Macao. Today, these cities form an almost continuous urban landscape with a strong industrial focus.





Profile

ANDRITZ HYDRO is one of the leading global suppliers of electro-mechanical equipment for hydropower plants. With over 170 years of accumulated experience and more than 30,000 turbines installed, totaling approximately 420,000 megawatts output, the business area supplies the complete product range, including turbines, generators, and additional equipment of all types and sizes – “from water to wire” for small hydro applications up to large hydropower plants with outputs of more than 800 megawatts per turbine unit. ANDRITZ HYDRO is also well positioned in the growing modernization, refurbishment, and upgrade market for existing hydropower plants. Pumps (for water transport, irrigation of agricultural land, and applications in various industries) and turbogenerators for thermal power plants are also allocated to the business area.



Market development 2014

Global project activity for electromechanical equipment for hydropower plants was satisfactory in 2014 and practically unchanged compared to the previous year, but still substantially below the peak level in 2011. In Europe, in particular, some larger hydropower modernization and rehabilitation projects were postponed or stopped due to

the continuing low propensity to invest. In the emerging markets, especially in South America and Africa, there were some new hydropower projects in the process of being implemented or in the planning phase. Project activity for small-scale hydropower plants and for pumps was solid.

Market data

Only one third of hydropower potential is being exploited

Around 21% of the world's electricity production comes from renewable energy sources. The renewable energy sources are split as follows:

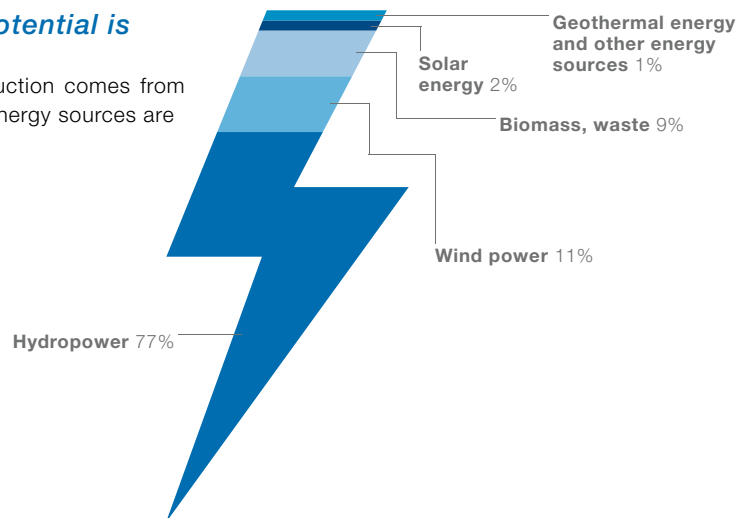

Experts estimate that only one third of the world's technically feasible hydropower potential is being exploited today. But a number of new hydropower plants are being planned or constructed and many outdated plants are in the process of modernization. By 2025, the current total output from hydropower of around 1,100 gigawatts is likely to increase to 1,500 gigawatts, corresponding with an average growth rate of 3.5% per year. The strongest growth rates are expected in Asia and South America, but an increase in clean, sustainable energy generation from water is also anticipated in all other regions of the world.

Regional share of 400-gigawatt approximate increase in total installed hydropower capacity expected by 2025

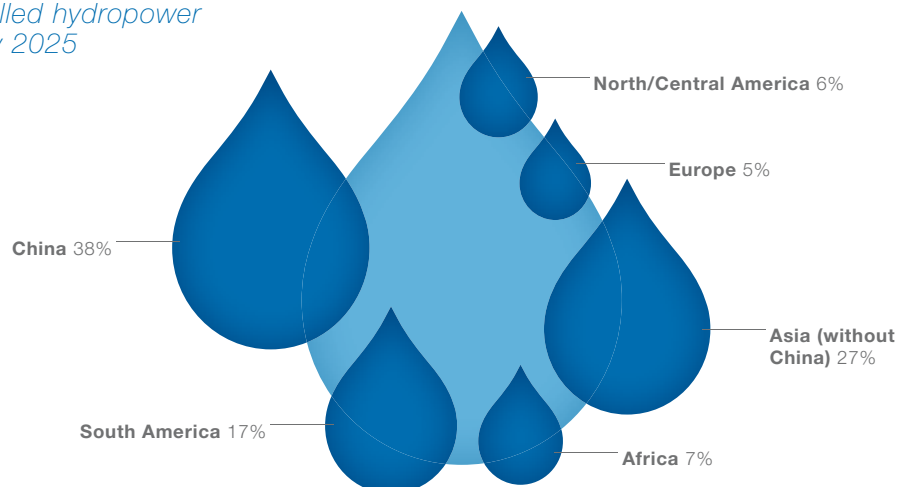



Significant need for modernization: more than half of hydropower turbines over 30 years old

The modernization of existing hydropower plants offers significant market potential and allows an output increase of up to 30%. The benefit for plant operators is that the investment needed for this increase in output is relatively low, with pay-back periods often less than three years. The driving force behind the modernization process is outdated equipment, as more than half of the turbines and generators used throughout the world are over 30 years old.

Regional share of hydropower output installed worldwide

In 2014, the total output was about 1,100 gigawatts

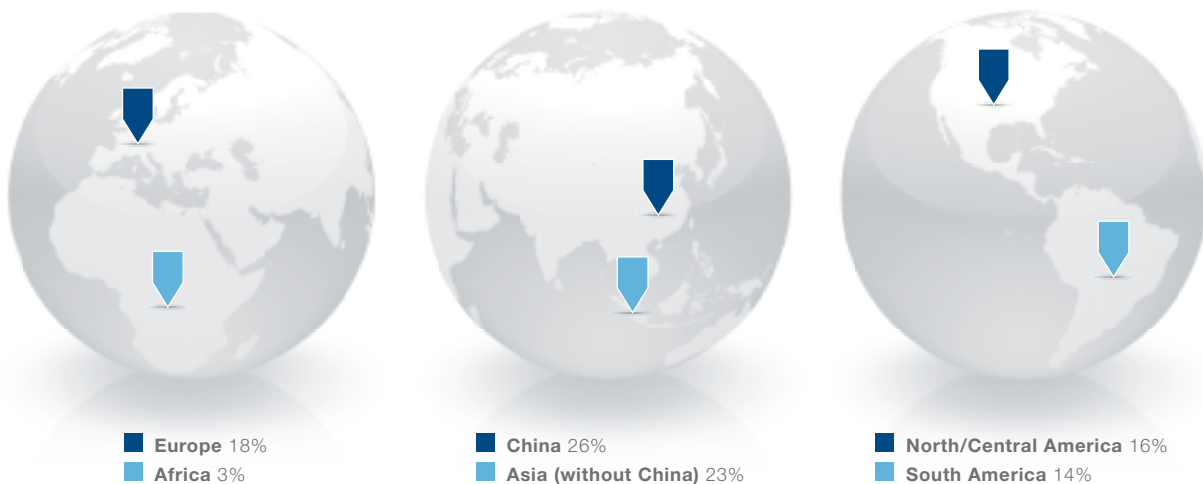

*Hydropower equipment more than 30 years old**



* Proportion of hydropower plants in operation
Sources: IHA, IEA, GlobalData, Hydropower & Dams World Atlas 2014

ANDRITZ HYDRO supplied a total of five Francis runners for Theun-Hinboun and Nam Gnouang hydropower stations.



United nations

The challenge:
complex projects

At the end of 2014, ANDRITZ HYDRO successfully completed the final handover of the Theun-Hinboun hydropower project in Laos. It was one of the most complex international projects that ANDRITZ had ever finalized.

It may only be 11 a.m., but the temperature is already 30 degrees Celsius and rising. The humid air hangs heavily like a damp curtain over the convoy as it crawls its way along the road. The drivers know what awaits them – a few kilometers up ahead is a bridge, before the route continues on through the jungle. It may not look far on a map, but this is a journey that will take several more hours at this speed. And with good reason: the convoy of transporters, guides, and police outriders is transporting a generator worth several million euros and weighing 100 tons. As the main transporter reaches the bridge, it slows to a crawl. The bridge has been temporarily reinforced so that it can support the weight of this special cargo, which is making its way to the Theun-Hinboun hydropower plant in the center of Laos in Southeast Asia, where it will be integrated into the expansion of the plant's existing hydro-power equipment.

The generator unit has made its way from the ANDRITZ workshops in Foshan, near the southeast coast of China. Transport across the South China Sea was a fixed routine – ANDRITZ has decades of experience in this. “The challenge came in moving the equipment from the port in Vietnam to the job site,” explains Harald Kessler, ANDRITZ HYDRO project manager for the Theun-Hinboun project. To do this, the company worked together with its local forwarder to perform extensive road surveys to select the right route, including carrying out any bridge reinforcement work necessary for particularly heavy loads. The weather

also had to be considered – large loads could only be transported during daylight hours in the dry season, dictating the schedule for the entire project.

Work on the expansion project began in 2008, when the Lao utility Theun-Hinboun Power Company decided to double the capacity of the Theun-Hinboun hydropower station from 220 to 440 megawatts. Having already worked successfully on the original Theun-Hinboun project, ANDRITZ HYDRO was commissioned to deliver an additional 220-megawatt turbine-generator unit including automation systems for the entire powerhouse, situated on the Nam Theun River. In addition, ANDRITZ received an order to supply two 30-megawatt turbines for another hydropower station on the Nam Gnouang River, 30 kilometers upstream.

“With regard to logistics, this was absolutely no normal project as a total of nine ANDRITZ HYDRO locations around the world were involved in its execution,” says

Technical data Theun-Hinboun

Output: 1 x 220 megawatts/245 megavolt ampere

Voltage: 10.75 kilovolts

Head: 228 meters

Speed (turbine): 214 revolutions per minute

Runner diameter (turbine): 4.6 meters

Stator diameter (generator): 9.2 meters

“ກ່ຽວກັບວຽກງານຂົນສົ່ງ,
ນີ້ແມ່ນໂຄງການໜຶ່ງທີ່ບໍ່ທໍາມະດາແທ້ໆ
ໃນຈໍານວນເກົ້າ
ໂຄງການທົ່ວໂລກ ທີ່ບໍລິສັດ
ANDRITZ HYDRO
ໄດ້ມີສ່ວນຮ່ວມເຂົ້າໃນວຽກງານການກໍ່ສ້າງ.”



Kongdasack Vannakaseum,
member of the ANDRITZ
HYDRO project team, Laos:
“With regard to logistics, this
was absolutely no normal project
as a total of nine ANDRITZ
HYDRO locations around the
world were involved in its
execution.”

Kongdasack Vannakaseum, member of the project team in Laos. ANDRITZ's headquarters in Austria was the location for the overall project management and installation and commissioning coordination. The 220-megawatt turbine-generator was designed in Canada and manufactured in China, where the design, manufacturing, and delivery of three turbine distributors, power transformers, and two Francis runners for the new Nam Gnouang plant took place across two sites. Design, manufacturing, and delivery work also took place at locations in India and Germany, while ANDRITZ HYDRO in Indonesia supported the installation of the electromechanical equipment.

In this **volute casing at the Nam Gnouang plant**, the water is fed to the turbine through the pipe, which contracts in a spiral shape. The vertical panels on the right-hand side of the picture are the stay vanes that bring the water to the turbine runner via the adjustable guide vane assembly. In this case, it is a Francis turbine which will be installed in the blue inner sector. The volute casing for Nam Gnouang was designed in Germany and China, manufactured in China, and installed by Laotians and Thais supervised by Canadian staff.

This partitioning demands extremely detailed coordination and provides advantages, as Alexander Schwab, Senior Vice President Market Management & Communication at ANDRITZ HYDRO, explains. "Spreading the work across different locations provides a great deal more flexibility. We were able to use resources of each location in the best possible way and thus provide cost advantages to the customer." In order to assure that quality remained high across each location, additional staff from the Austrian generator site was sent to the main workshops where the key components were produced. Other ANDRITZ experts from Austria, Germany, and Canada attended quality tests and acceptance work in China and India.

Unconventional methods of communication

The true international nature of the project could also be seen on site in Laos' Bolikhamxay province. "While ANDRITZ HYDRO was contractually obliged to employ 150 local workers, there were people from more than ten nations on site," reports Harald Kessler. "This led to one of



the project's biggest challenges: communication within the team." Inevitably, levels of English ranged from non-existent to fluent, so the solution was to find English-speaking staff for key positions such as foremen and group leaders. "Nevertheless, unconventional methods of communication were sometimes required, such as hand gestures or drawings on whatever was to hand, be it paper, sand, or even walls," Kessler says. "Thus very close professional supervision was needed to avoid misunderstandings."

One advantage was that work on the Theun-Hinboun project began shortly after the completion of the Nam Theun 2 hydropower plant, located 100 kilometers away, for which ANDRITZ HYDRO had also supplied electromechanical equipment. "This meant we were able to occupy

A 100-ton generator had to be transported through jungle area and rough terrain.

almost every key position with someone who had recently worked on Nam Theun 2," says Kessler.

With so many nationalities involved, of course cultural differences affected numerous aspects of the project. "European workers often have a completely different view on safety to those from Asia or America, for example," Kessler explains. "Initially, some of the Lao employees arrived on site wearing flip-flops and no helmet, whereas North Americans tend to be the complete opposite."

Religious beliefs also had to be taken into consideration, with the work camp inaugurated through a special cere-



Worldwide, nine ANDRITZ HYDRO locations were involved in the Theun-Hinboun and Nam Gnouang projects



Vienna and Weiz, Austria:

Overall project management, installation coordination and supervision, commissioning coordination, site management, design of generators for Nam Gnouang

Peking and Hangzhou, China:

Design, manufacturing, and delivery of three turbine distributors and two Francis runners for Nam Gnouang, electric power system, power transformers, and generator for Theun-Hinboun

Peterborough and Point-Claire, Canada:

Design, manufacturing and delivery of generator for Theun-Hinboun

Bhopal, India:

Design, manufacturing, and delivery of generators for Nam Gnouang and of generator poles for Theun-Hinboun

Ravensburg, Germany:

Design, manufacturing, and delivery of Francis runners and main inlet valve for Theun-Hinboun

Jakarta, Indonesia:

Installation of electromechanical equipment

mony led by monks from the nearby Buddhist temple and Islamic halal food offered by the catering team, alongside a choice of other dishes from around the world.

Generating more than just electricity

Deliveries for the Theun-Hinboun and Nam Gnouang hydropower plants were completed on time and on budget. "Careful planning meant that during the installation of the new 220-megawatt Francis unit at Theun-Hinboun outages were kept to an absolute minimum. In addition, we also exchanged the automation system for

the existing units in just 35 days," comments Kessler. "A very short timeframe."

The Nam Gnouang plant serves a dual purpose. As well as generating electricity for two local provinces during the wet season, the reservoir stores rain that falls between May and October. During the dry season, this water is then released into the river to help the larger powerhouse

Technical data Nam Gnouang

Output: 2 x 30 megawatts/33 megavolt ampere

Voltage: 11 kilovolts

Head: 47 meters

Speed (turbine): 188 revolutions per minute

Runner diameter (turbine): 2.9 meters

Stator diameter (generator): 5.8 meters



ANDRITZ's great experience in Laos

ANDRITZ is currently working on supplying electromechanical equipment for the Xayaburi run-of-river hydropower station in Laos. Start-up is scheduled for the end of 2019. The technology offered by ANDRITZ HYDRO and the successful supplies for the Theun-Hinboun, Nam Gnouang, and Nam Theun 2 hydropower plants were decisive in winning the Xayaburi order. Nam Theun, which went into operation in 2010, is considered a showcase project worldwide for sustainable hydropower plants in which numerous accompanying social and ecological measures were implemented successfully in compliance with the guidelines of the World Bank and the International Monetary Fund.

at Theun-Hinboun continue to generate electricity. A new intake and tunnel system channels the water down to the expanded powerhouse, a drop of almost 230 meters, where it rushes through the turbines before a generator converts the mechanical energy into electrical energy. While some of the energy generated at Nam Gnouang helps provide power to many thousands of local residents, the electricity from Theun-Hinboun is taken by transmission lines just over 80 kilometers west, across the Mekong River into Thailand, bringing significant income for the Lao government.

While the Theun-Hinboun project entered service just over two years ago, Harald Kessler’s work in Laos only recently came to an end. His passports have registered 30 Laos trips during the last three years, which includes a two-year warranty period on the ANDRITZ equipment installed. “Everything has gone well,” he says. “A

handful of minor issues have been rectified and the three turbine-generator units are all running to the customer’s and our satisfaction.”

It may not be the biggest project that ANDRITZ HYDRO has worked on, but the challenges were enormous. “It was a very complex project – the number of nations involved made it very unique. The fact that we completed it successfully will provide valuable experience for all involved,” says Kessler.

Successful reference projects by suppliers play a decisive role when hydropower plant operators consider placing future orders. “The Theun-Hinboun and Nam Gnouang projects have contributed to our good name in Laos and the Southeast Asian region,” says Alexander Schwab. “In a country that is full of hydropower potential, this should help us in the future.”

Geoff Poulton, Laos

A strong position in important growth markets

In many countries in Southeast Asia, Australasia, and Oceania, the hydropower market is booming. The main driving forces are rapid population growth, the large number of people who currently have no electricity supply at all, the increasing demand for energy from a fast-growing economy, the decision made by many governments to focus on clean hydropower for energy generation, and the as yet unexploited potential of hydropower in many places. ANDRITZ HYDRO is a market leader in many countries in this region.

Hydropower capacity

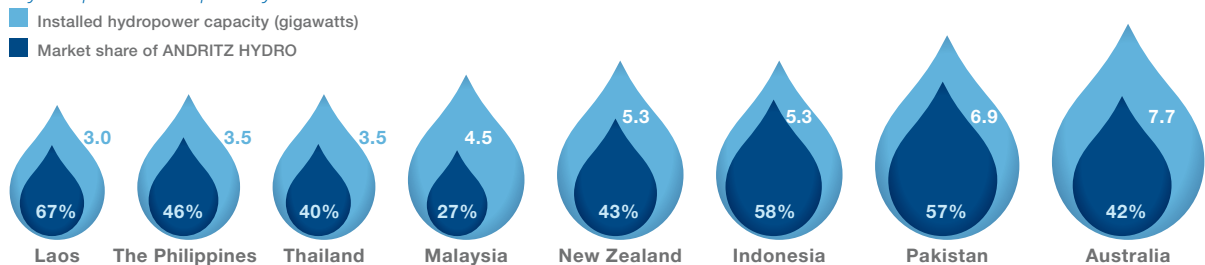

Source: HP&D World Atlas 2014

Greatest potential in Laos, Malaysia, Pakistan, Indonesia, and New Zealand

The largest future markets for the expansion of hydropower include Laos, Malaysia, Pakistan, Indonesia, and New Zealand. In these growth regions, the current development of hydropower, measured against the entire amount of domestic power generation, still differs significantly. Whereas Laos generates its power almost entirely from hydropower (98%), in New Zealand this figure is more than half (53%), in Pakistan approximately one third (29%), and in Malaysia and Indonesia 19% and 11%, respectively. However, the technically feasible hydropower potential in these countries is enormous. It could not only cover the entire domestic power requirement from hydropower – Laos’ hydropower could generate almost seven times as much as the total amount of domestic power generated today, while Malaysia, Pakistan, Indonesia, and New Zealand could each generate twice as much.

The challenge: sustainability

Generating a brighter future

Hydropower plants in Laos are considered showcase projects in sustainable social and ecological development. Unavoidable but necessary encroachments on living conditions of the local population and on the environment are cushioned as best as possible – while the local population profits from better health care, infrastructure, and education.

Just a few years ago, many of the towns and villages in the Bolikhamxay and Khammouane provinces were shrouded in deep darkness when the sun went down. Now, thanks to the energy generated by the Theun-Hinboun and Nam Gnouang hydropower plants, many of them enjoy a reliable electricity supply. While this is one of the more obvious advantages brought by hydropower development to the region, there are many others, ranging from new roads and schools to health clinics and improved sanitation.

As one of the poorest countries in Southeast Asia, in which almost 30% of its population lives below the national poverty line, improvements such as these are vital for Laos. For several years, the Lao government has expressed its desire to become the “battery of Southeast Asia” thanks to the massive hydropower potential offered by the Mekong River. Currently, only just over 10% of this potential has been tapped, despite the huge opportunity it represents to stimulate economic growth and reduce poverty – because hydropower extension has to be implemented very carefully. Large projects inevitably leave their mark on both local inhabitants and the environment, but, if managed correctly, their positive effects can outweigh this.

Strict social and environmental guidelines

As Laos looks to benefit from hydropower as one of the country’s few significant energy resources, the government has introduced a number of policies to ensure that the hydropower industry is developed sustainably. Power companies operating plants such as Theun-Hinboun or Nam Theun 2, in which ANDRITZ HYDRO was also involved as electromechanical equipment supplier, must adhere to strict social and environmental guidelines. The World Bank and Asian Development Bank, which contribute funding for many of the hydropower projects, also have numerous safeguard policies in place to protect both the environment and local inhabitants, as well as carrying out regular reviews on projects, identifying where improvements can be made.



The population profits from the Theun-Hinboun and Nam Gnouang hydropower plants, not only due to the stable power supply, but also the improved drinking water supply, new roads, schools, and hospitals.





Sharing benefits

It is a constant learning and improvement process, with projects such as the original Theun-Hinboun hydropower station, which was completed in 1998, and Nam Theun 2, which entered service in 2010, providing valuable lessons for the recent Theun-Hinboun expansion project. At Nam Theun 2, located approximately one hour's drive further south of Theun-Hinboun, the Nam Theun Power Company (NTPC) worked with a number of local and international partners to introduce 120 kilometers of new, all-weather roads, 1,300 houses for local people, each with electricity and toilets, 16 kindergartens, and 16 schools. Handling resettlement of people affected by a large hydropower

As one of the poorest countries in Southeast Asia, in which almost 30 percent of its population lives below the national poverty line, improvements as part of hydropower projects are vital for Laos. However, hydropower extension has to be implemented very carefully. Large projects inevitably leave their mark on both local inhabitants and the environment, but, if managed correctly, their positive effects can outweigh this.

plant is a very sensitive subject, but expertise from the NTPC has been transferred to the Theun-Hinboun Power Company (THPC) and its Theun-Hinboun expansion project. Thus THPC was able to ensure as best as possible to share the benefits from the project with local people and keep social and ecological disruption to a minimum. So far, THPC has spent 50 million euros on its social and

ecological investment programs, with millions more set to follow in the coming years.

Following the creation of the Nam Gnouang reservoir, around 4,000 locals moved into custom-built communities in both new and existing villages. Local committees comprising village leaders have been heavily involved throughout the resettlement process. While the resettlement policy means these people receive immediate benefits in terms of new housing, THPC also helps them to learn new skills, ranging from engineering to agriculture and fishing, to boost their income. During the construction periods, THPC employed up to 2,500 people, with around two-thirds of them from Laos and the vast majority of them locals. Improved infrastructure, a better power supply, and higher income levels have also enabled numerous people to open a variety of shops.

Public health has also been a focus for THPC. Free health care is now available for many residents in the

Theun-Hinboun area for the first time, while the new roads have made it easier for people to access the new clinics that have been built. Community education programs are helping provide a better understanding of how locals can prevent some of their most common health problems.

Strict environmental standards

With so many locals reliant on the surrounding land for their income, THPC and the other organizations and companies involved in the Theun-Hinboun expansion project have made it their priority to ensure disruption has been kept to a minimum. A special environmental unit was set up, which has been involved from the planning stage onward. During construction, the unit ensured that strict environmental standards were upheld across the various sites. Today, the unit is regularly monitoring possible environment impact, for example regarding fish stock levels.

Geoff Poulton, Laos



Highlights 2014



Europe

ANDRITZ HYDRO will modernize six 140-megawatt Francis turbines on behalf of Iberdrola Generación for the Aldeadávila hydropower plant, Spain. Aldeadávila (1+2) with a total of eight machine units installed and an overall output of more than 1,200 megawatts is the largest hydropower plant in Spain and has one of the highest outputs in Southwestern Europe.

The business area received an order from Lyse Produksjon utility company to supply the electromechanical equipment for the new Lysebotn II hydropower station, Norway. The supply includes two high-pressure Francis turbines (each with an output of 185 megawatts) and two generators. Due to the favorable reservoir situation, the generating units for this underground hydropower station are designed for frequent start/stop to optimize energy production. Lysebotn II will replace an existing hydropower plant and increase the annual electricity production by almost 15% to reach 1.5 terawatt-hours.

For the Obervermunt hydropower plant operated by Vorarlberger Illwerke AG, Austria, ANDRITZ HYDRO is supplying two Francis turbines (180 megawatts each).

Officine Idroelettriche di Blenio ordered the replacement of both main units in the Olivone hydropower plant, Switzerland. The order includes supply of two 60-megawatt Pelton turbines as well as generators. Also in Switzerland, ANDRITZ HYDRO, as part of a consortium, will replace four existing Pelton units with two new six-jet Pelton units with a total output of 31 megawatts for the Bramois hydropower plant on behalf of Forces Motrices de la Borgne.

ANDRITZ HYDRO received an order from Länsi-Suomen Voimato to modernize the two existing Kaplan turbines and supply an additional, new 23-megawatt Kaplan turbine for the Harjavalta hydropower plant, Finland. The modernization project will increase the plant's output by around 30%. In addition, Fortum Power and Heat ordered modernization of electromechanical equipment at the Lippikosko 1 and 2 and the Nuojua 3 hydropower plants.

The turbines at the Bjurfors Nedre and Övre hydropower stations will be refurbished for the Swedish utility Statkraft, Sweden.

Fully networked secondary technology is being supplied for five hydropower stations on the upper reaches of the River Inn, Germany, on behalf of Verbund Innkraftwerke. By 2021, 21 units will be equipped with new secondary technology to enable fully automatic operation.

In the Georgian Republic, the business area will provide the equipment for the Dariali hydropower station: Dariali Energy JSC has ordered delivery and installation of the turbines, generators, and automation systems.

Following extensive modernization work, two Kaplan turbines were started up for the Iovskaya hydropower station, Russia, on behalf of the regional utility company Kolsky Branch of JSC TGK1.

North America

ANDRITZ HYDRO received an order from Chelan County Public Utility District, USA, to refurbish unit #6 at the Rock Island hydropower plant. The order includes supply, installation, and commissioning of the unit, comprising a 28-megawatt Kaplan turbine with generator, and rebuild work on four other units.



South America

The business area is to supply and install the entire electrical and hydromechanical equipment for the Ñuble hydropower plant, Chile, on behalf of Hidroeléctrica Ñuble, a subsidiary of the Chilean utility company Eléctrica Puntilla. The hydropower plant will have a total output of 136 megawatts and supply an annual 700 gigawatt-hours of sustainable energy from hydropower to the Chilean grid.



Also several important modernization contracts were secured in South American countries, including Venezuela (additional order from Corpoelec for the Simon Bolivar II hydropower station) and Colombia (modernization of the Alto Anchicaya hydropower plant and supply of three new Francis turbines each with an output of 16.5 megawatts for the Prado Tolima hydropower plant on behalf of Empresa de Energía del Pacífico). The Cerro del Aguila hydropower plant, Peru, will be fitted with an additional Francis turbine in order to improve the ecological flow.

In the small-scale hydropower sector, where ANDRITZ HYDRO leads the world market, the business area booked numerous important orders worldwide during the reporting period. These include a delivery to Hidrelgen, Ecuador, comprising the entire electromechanical equipment with turbine and generator for the Sabanilla small-scale hydropower plant. Outside South America, orders booked for small hydropower plants included Chaudière (Canada), Bocac II (Bosnia), Calikobasi (Turkey), El Recreo 2 (Guatemala), and North Mathioya (Kenya).

ANDRITZ HYDRO received an order from Triunfo, Brazil, to supply the electromechanical equipment for the Sinop hydropower plant. The scope of supply includes two machine units, each with an output of 204 megawatts. There were also two important start-ups in Brazil. The first of eight bulb turbines to be supplied to the Jirau hydropower plant was handed over successfully. The business area will deliver a total of eight bulb turbines (output 76.4 megawatts each), seven generators, and 28 excitation systems for Energia Sustentável do Brasil in the next two years. At the Batalha hydropower plant, machines 1 and 2 started commercial operation. A consortium headed by ANDRITZ HYDRO supplied the electromechanical equipment including two Kaplan turbines with a total output of 54 megawatts, ordered by Furnas Centrais Elétricas. The Furnas Group is one of the largest utilities in Brazil and supplies electricity to two-thirds of all Brazilian households.



Tidal hydropower #1: the first commercial order worldwide to supply tidal current turbines

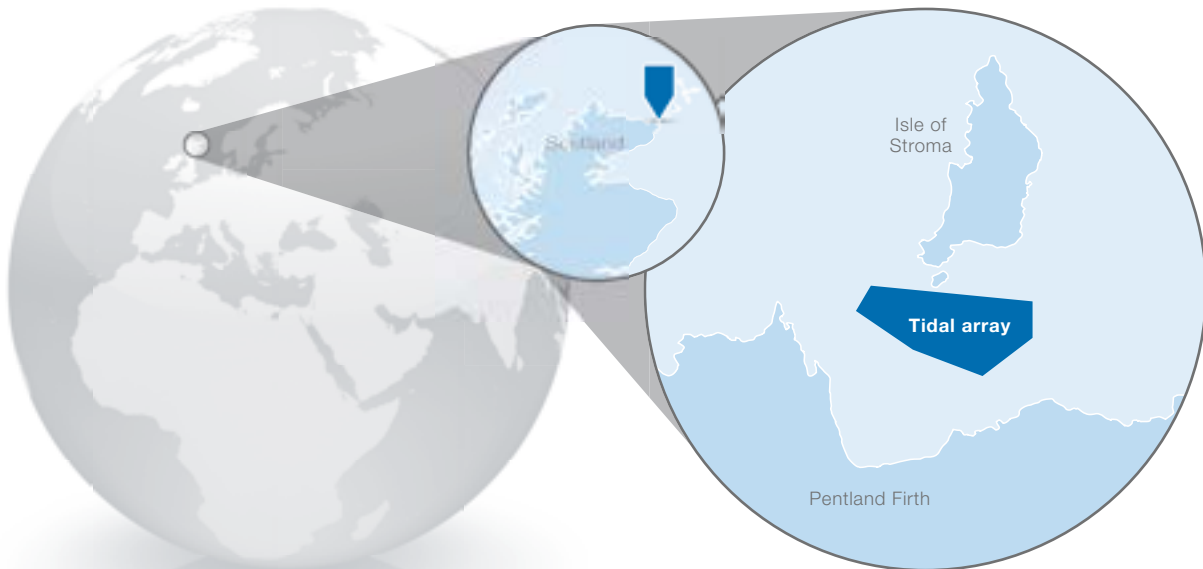

ANDRITZ HYDRO Hammerfest will supply three 1.5-megawatt tidal current turbines for the planned tidal array in the Inner Sound of the Pentland Firth, Scotland, on behalf of MeyGen Ltd. The tidal current turbines are anchored to the sea bed in coastal waters and driven by the high flow of water created by the rising and falling tides. This order is the first commercial order worldwide to supply tidal current turbines and part of the first project phase in the completion of the MeyGen tidal array, which is the largest development project worldwide for a tidal turbine array. In the long term, MeyGen is planning to install a total of 269 turbines with an overall output of 398 megawatts, which will provide predictable, renewable, and sustainable energy for 175,000 Scottish households.



Photo: Yannick Le Gal/Électricité de France

Tidal hydropower #2: ANDRITZ turbines for the world's oldest tidal power plant

ANDRITZ HYDRO received an order from Électricité de France to modernize five out of the total of 24 ten-megawatt bulb turbines for the La Rance tidal power plant, France. This plant in Brittany is the oldest in the world and the second largest tidal power plant worldwide – the largest is in South Korea and was also equipped with turbines from ANDRITZ HYDRO. These power plants operate according to the barrage principle and are installed in coastal bays or river estuaries that can be closed off by a dam. At the La Rance plant, the reversible bulb turbines in the dam are driven by the water currents produced at high and low tide. The turbines have fixed rotor blades and simply change their direction of rotation.



equipment for the Middle Bhotekoshi 102-megawatt hydropower plant, Nepal. The scope of supply comprises three Francis turbines, generators, spherical valves, and the electrical auxiliary equipment. The hydropower plant will generate more than 542 gigawatt hours of electricity from sustainable resources every year.

For the Xekaman 1 hydropower plant, Laos, ANDRITZ HYDRO received an order from Song Da Construction Corp of Vietnam and Viet-Lao Power Investment and Development Joint Stock Company to supply the complete electromechanical equipment, including two Francis turbine generator units with an output of 147 megawatts each.

AGRIMECO awarded the business area an order to supply electromechanical equipment for the Chi Khe hydropower station, Vietnam. The hydropower plant will be fitted with two bulb turbines and have an installed capacity of 41 megawatts.

Eighteen multi-stage split-case pumps will be supplied for a water transport project in the city of Yuxi, Yunnan province, China. The pumping station being supplied conveys 2.5 cubic meters of water per second and contributes to the water supply for two million people in Yuxi.

Six vertical line shaft pumps were started up successfully at the Rampura pumping station, Bangladesh. The pumping station supplies water to the Bangladeshi capital city of Dhaka.

Africa

The Ministry of Energy and Water in Angola placed an order for supply of the electromechanical equipment for the new Laúca hydropower plant. The scope of supply comprises six 340-megawatt Francis turbines, six generators, auxiliary equipment, and a 72-megawatt machine to guarantee the minimum flow rate.



For Eskom Generation, the electromechanical equipment including three 40-megawatt Kaplan turbine units at the Manantali hydropower plant, Mali, will be refurbished.

Liberia Electricity ordered upgrading of the hydraulic steel work for the Mt. Coffee hydropower station, Liberia.

Four 2.4-megawatt double-suction submersible motor pumps are being supplied to drain a disused gold mine in South Africa.

Australia

In addition to the order to supply a 23-megawatt Kaplan turbine for Hydro Tasmania's Cluny hydropower station, the business area started up the Paloona 32-megawatt hydropower plant. Hydro Tasmania selected the business area to modernize and increase the outputs of the Paloona and Meadowbank hydropower plants in 2011. In view of the mountainous countryside and rainy climate and in order to protect the environment, the state utility focuses on clean, renewable energy and operates 27 hydropower plants that are considered worldwide to be ecologically sustainable reference projects.



Asia

The business area received an order from Water & Power Development Authorities for supply of three 36.7-megawatt Pelton turbines, three generators, and electromechanical equipment for the Golen Gol hydropower plant, Pakistan.

Madhya Bhotekoshi Jalvidyut awarded ANDRITZ HYDRO the order for delivery of electromechanical





Profile

ANDRITZ PULP & PAPER is a leading global supplier of equipment, systems, and services for the production and processing of all types of pulps, paper, tissue, and cardboard. The technologies cover the processing of logs, annual fibers, and waste paper; the production of chemical pulp, mechanical pulp, and recycled fibers; the recovery and reuse of chemicals; the preparation of paper machine furnish; the production of paper, tissue, and board; the calendering and coating of paper; as well as treatment of reject materials and sludge. The service range includes modernization, rebuilds, spare and wear parts, service and maintenance, as well as machine transfer and second-hand equipment. Biomass, steam, and recovery boilers, as well as gasification plants for power generation, flue gas cleaning plants, production equipment for biofuel (second generation), biomass plants for the production of nonwovens, dissolving pulp, plastic films, and panelboards (MDF), and recycling plants are also allocated to the business area.



Market development 2014

The international pulp market saw satisfactory development in 2014. Continuing good demand, mainly from international tissue and packaging paper producers, and stable supply, led to a price increase in long-fiber pulp (northern bleached softwood kraft) from around 860 US dollars at the beginning of January to approximately 930 US dollars per ton by the end of 2014. The price of short-fiber pulp (eucalyptus) decreased from around 780 US dollars at the beginning of January to about 740 US dollars per ton at

the end of 2014. The reasons for this were the subdued demand from Chinese paper producers and the increasing pulp supply from new pulp mills that started up production in 2014. The market for pulp mill equipment developed well. A number of larger modernization orders were awarded and the investment and project activity for new pulp mills was satisfactory. However, the competitive environment for pulp equipment suppliers continued to be challenging, with high price pressure particularly on large projects.

Market data

Clear cost advantage for South American pulp producers

The creation of new production capacities, in particular in South America, is a major long-term market driver in the pulp industry. Because of the beneficial climatic conditions and the resulting faster tree growth, pulp mills in the southern hemisphere (particularly in areas just south of the equator) have significantly lower production costs than comparable factories in other regions. This huge cost advantage and the growing global demand for tissue paper, cardboard, and packaging paper have resulted in many well-known pulp producers planning to build additional new pulp mills in South America over the next few years.

Cash cost per ton of pulp produced (in US dollars)*

* Bleached hardwood kraft pulp

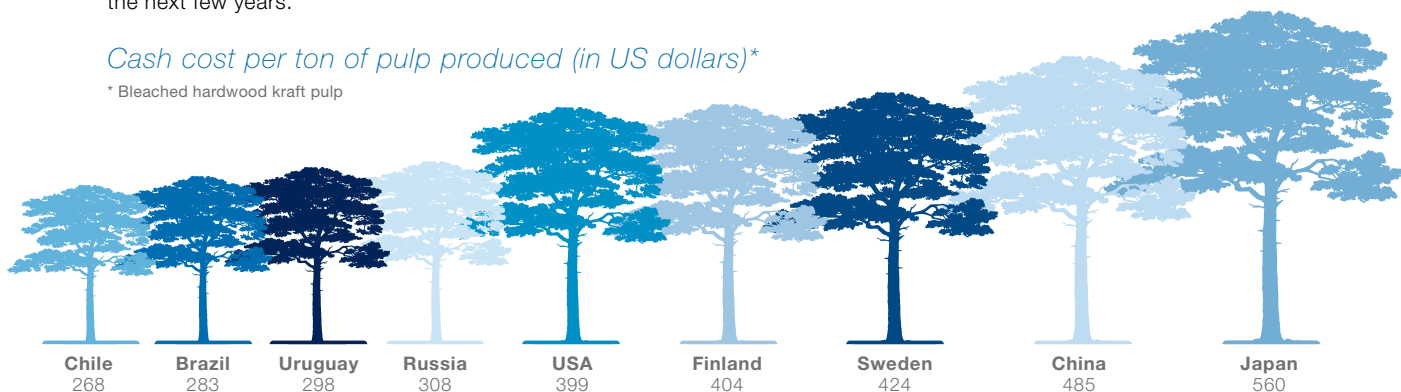

Chemical pulp capacity by region*

In 2014, the total capacity amounted to about 140 million tons

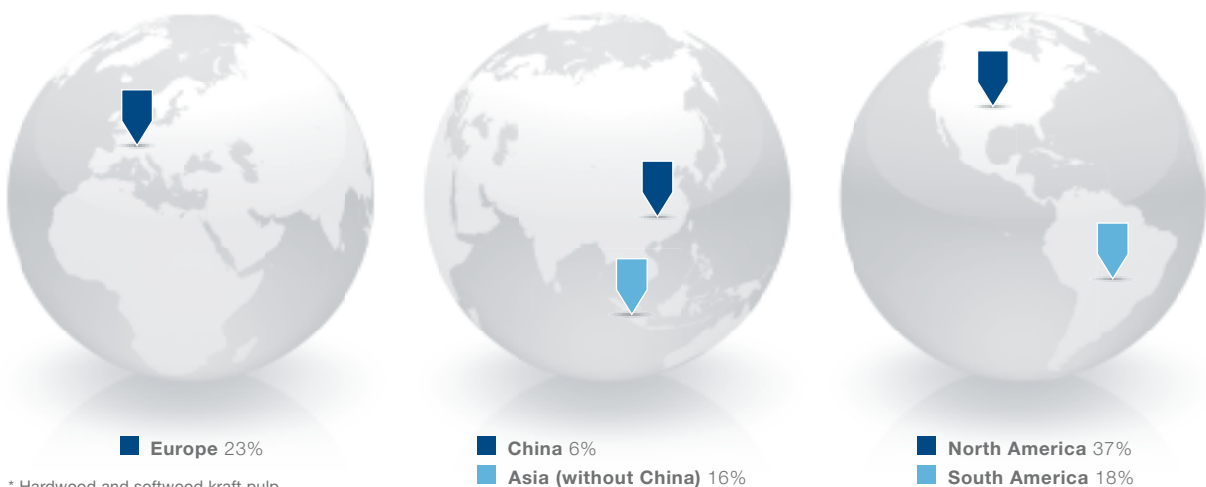

* Hardwood and softwood kraft pulp
Sources: RISI, Pöyry



Major modernization drive for pulp mills

There is significant market potential in modernizing existing, partly outdated pulp mills. Current studies show that the average age of pulp plants in Asia (without China) is 19 years, in Europe 22 years, and in North America as much as 33 years. The long-term market drivers of modernization are increasingly stringent environmental legislation and the considerably higher operating costs and lower efficiency levels of older factories, when compared with new plants. The operating costs can be significantly reduced by modernizing individual processes in existing older mills. One example is the replacement of biomass and recovery boilers, which can allow pulp producers to make their plants self-sufficient in energy and to feed excess energy into the public electricity grid in the form of green biomass electricity. This results in a considerable reduction in pulp production costs and an increase in the competitiveness of the plant.

Average age of pulp mills

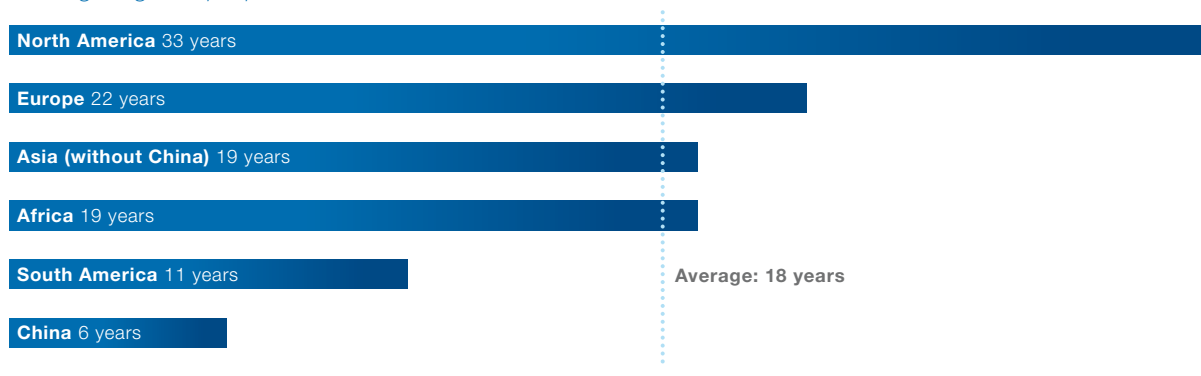

“Suomalaisen teknologian avulla

Brasiliassa

tehdään selluloosaa,

josta valmistetaan

Ruotsissa

paperinenäliinoja,

joita taas ystäväni

Suomessa

käyttävät.”



Taisto Salakka, ANDRITZ Project Manager, Finland:
“Technology from Finland produces pulp in Brazil, which makes tissue in Sweden that is used by my friends in Finland.”



This map dated 1625 shows Lake Parime, on the western shore of which "El Dorado" is said to have lain. The ancient legend of the city of gold in South America has been replaced by a new and true legend: that legend of Eldorado Brasil, the largest and most modern pulp mill in the world.

The new legend of Eldorado

**The challenge:
large projects (1)**

The legend of "El Dorado," a mythical city of gold, enticed European explorers to South America during the 16th and 17th centuries. Today, Eldorado stands for a new, modern, and real legend: on behalf of Eldorado Brasil, ANDRITZ built the largest pulping line in the world. This was a global project with enormous challenges.

"I now pronounce you man and wife. You may kiss the bride."

As tears of joy begin to flow at the wedding near Lahti, Finland, tissues emerge from purses and pockets. No one gives the small and practical squares of tissue a second thought. No one, that is, except Taisto Salakka.

Taisto knows about tissue production and pulp making technology. He works for ANDRITZ PULP & PAPER in Lahti. He knows that the tissue manufacturer, a Swedish company, buys its pulp from Eldorado Brasil, and that the main technology for producing this pulp was delivered by ANDRITZ. He was one of the project managers for the Eldorado pulp mill.

"Technology from Finland produces pulp in Brazil, which makes tissue in Sweden that is used by my friends in Finland," Taisto Salakka says with a smile. "Globalization at its best. It's all part of a grand, global circle." Actually, the grand circle included ANDRITZ companies in Austria, Brazil, China, Finland, Germany, and Sweden. Subcontractors from Brazil, China, Denmark, Estonia, Italy, and the USA were also employed.

Much of the world's short-fiber wood pulp comes from Brazil. The leading pulp mills use proven ANDRITZ technology for wood processing, cooking, washing, bleaching, and pulp drying. This was key in ANDRITZ winning the order at Eldorado in November 2010. According to Carlos Monteiro, Eldorado Brasil's Industrial and Technical Director, many pulp projects were "frozen" due to the



Eldorado Brasil supports a number of local sustainability projects, for example "Patrulha Florestinha" ("Little Forest Patrol"), which focuses on children's environmental awareness and recreational activities outside school.

economic crisis at that time. Seeing a window of opportunity to have a new mill built and started up very quickly, Eldorado was moving full speed ahead.

Eldorado Brasil knew how to keep its costs low – buying at the right time and minimizing its supervisory staff. "We had a very small group to oversee the project," Monteiro says. "We relied very much on the expertise of ANDRITZ."



Global technologies – local expertise

As one of the key Engineering, Procurement, and Construction (EPC) contractors, ANDRITZ was responsible for all the critical activities – basic engineering, detailed engineering, civil/structural construction, equipment delivery, mechanical erection of the equipment, instrumentation and automation, commissioning, and start-up, as well as process guarantees.

The ANDRITZ technologies had been proven successfully in operation many times, but not at Eldorado scale. For example, the woodyard consists of three chipping lines and the world's largest stacker-reclaimer system in operation. The continuous digester is the largest in the world. Eight large Drum Displacer (DD) washers deliver clean pulp to the pulp drying plant with the lowest chemical consumption achievable. The lime reburning kiln, with its energy-saving features and high efficiency, is the largest in South America.

The ANDRITZ team in Europe was responsible for the basic engineering, process design, and delivery of the key equipment. The Brazilian team took care of the detailed engineering, local equipment, on-site construction, and on-site erection. Commissioning and start-up was performed by a blend of experts from all over ANDRITZ. In total, about 240 ANDRITZ people were involved at the Eldorado mill site.

Large project logistics

The interfaces and handoffs were very complex. In addition to ANDRITZ employees in Austria, Brazil, China, Finland, Germany, and Sweden, there were 200 manufacturing subcontractors, eight engineering subcontractors, 15 construction and erection subcontractors, as well as about 4,000 workers on site. Many of these people were from Brazil and other parts of South America.

The schedule was extremely challenging – start-up just 24 months from the signing of the contract. As Luis Bordini, Head of ANDRITZ Brasil and Project Director for Eldorado, explains, “At any moment, it was like juggling ten balls. When you get them moving in the same direction with the same momentum, it gets easier. But, you can never take your eyes off the moving balls.”

The main challenges to be coordinated from the product homes in Europe were the design, manufacture, and transportation of the equipment, as well as structural steel from China. “In total, there were 1,063 containers in 161 shipments, and nearly 35,000 cubic meters of bulk cargo in 18 shipments,” says Satu Aronen, Procurement Manager Logistics. A Brazilian freight forwarding company worked inside the ANDRITZ office in Curitiba, Brazil, to simplify communications and coordination.

One of the challenges for the Brazilian project team was to supervise the movement of supplies from Europe



All technical challenges mastered: Eldorado pulp mill, Brazil.

At the height of construction, there were up to 13,000 people on site at the same time, with about 150 from ANDRITZ. Things were progressing well. And then a major blow. In month 16, the largest construction contractor at the site had a change of ownership and went bankrupt. "This was a tough, tough period," Luis Bordini recalls. "We worked as quickly as we could to find a solution. Some of the civil and construction work could be absorbed by other subcontractors. We had to pay some of the workers from the bankrupt company ourselves to keep them on the site. This created about 30 to 40 days delay, which we had to make up."

Eldorado Brasil was unwavering in wanting to keep to the schedule. What followed was a very intense and stressful period. The effort paid off. Chips began flowing to the digester from the woodyard on November 24, 2012. As pulp started flowing, the customer was able to meet its commitments to its owners.

On an average day, the mill processes 135,000 logs and produces 4,800 tons of pulp bales ready for market. Day in, day out, with few exceptions. Thus, the annual capacity amounts to 1.7 million tons. Considering that the ANDRITZ equipment was sized for around 1.5 million tons, that is a remarkable achievement.

"Think about it," says Carlos Monteiro of Eldorado Brasil as he looks over the mill. "This mill began as an empty plot of land in March 2010. In about two years, we built the world's largest pulping line, with the world's most modern technology. The line started up on schedule in December 2012 and is producing above the target level. We are already planning the next line. The decision to take ANDRITZ as a partner was the right one."

Robert Puhr, Brazil

through the port of Paranaguá in Brazil to the inland mill site 900 kilometers away. Large equipment required special handling. Newton Kozak from ANDRITZ explains the arrangements required to move each of the huge washer drums and the chip bin sections to the mill. "There is a bridge on the road from Paranaguá to the mill site with a height limit of 5.3 meters. Taller shipments had to be re-routed on the other side of the highway to avoid the bridge. This meant securing special permits and arranging for the police to block the highway. An electric company also had to disconnect overhead cables so the trucks could pass. Authorities would only allow this to happen one day a month, so the deliveries had to be carefully staged."

Unforeseeable bumps in the road

Another challenge was the labor situation in Brazil. With huge projects for the Olympics and the Soccer World Cup, there was difficulty in attracting construction people to a mill site far from a major city. As Project Manager Juliano Vieira remarks, "We were constantly seeing new local faces, which meant re-training."

Eldorado's record production

The bankruptcy of the largest construction contractor created a domino effect that made it seem almost impossible to meet the already tight schedule. In the end, the extra efforts taken resulted in schedule commitments being kept. Through some adjustments and small investments made since start-up in 2012, performance of the world's largest pulping line has increased steadily and consumption of steam, energy, and water in the pulp drying plant, for example, has been reduced significantly. "We had many challenges, and these were addressed in collaboration with the customer," summarizes Karl Eickhoff, Global Product Group Manager for Pulp Drying at ANDRITZ. Eldorado set three consecutive world records for daily pulp production in March 2014 (peak: 5,156 tons). Then in August, the latest record – 5,300 tons in a single day – was achieved!

„Az általunk Pöls-be szállított

**papírgép Európában
az egyik legnagyobb.**

Ez a projekt hatalmas kihívás
volt számunkra, amivel csak azért
tudtunk olyan gyorsan és

sikeresen

megbirkózni, mert

országhatárokon átívelően

**is jól együtt tudtunk
működni.“**



**Robert Duschig, Technical Director
at ANDRITZ in Tiszakécske, Hungary:**

“The paper machine we have supplied to Zellstoff Pöls is one of the largest in Europe. The project represented a huge challenge which we were only able to overcome so quickly and successfully because we worked together very well across several countries.”



The flying rhino is a trademark of Zellstoff Pöls AG – a symbol of its strength and readiness to provide top performance at any time.

The rhino has landed

The challenge:
large projects (2)

One of the largest paper machines in Europe came into full operation in the Austrian town of Pöls in 2014. For ANDRITZ, manufacturing and installing the machine was a record-breaking project. It has also become an important reference site for the company's expertise in producing complete production lines.

Flying rhinos are generally a fairly rare occurrence. But on November 10, 2013, a particularly impressive example landed in the small Austrian market town of Pöls. This was the date on which Europe's largest kraft paper machine began operating at Zellstoff Pöls AG and produced the first roll of the company's Starkraft paper, which has a flying rhino logo. For Zellstoff Pöls, the flying rhino is a symbol of its strength and readiness to provide top performance at any time.

looks back on the initial discussions with the customer. "Zellstoff Pöls wanted the new machine to have a similar design to the existing one, but with five times the production capacity and much greater flexibility." Zellstoff Pöls manufactures kraft papers for food packaging, carrier bags, gift wrap, and medical applications on the basis of as many as 180 specifications. The aim was for the new machine to allow for very fast changeovers which would make just-in-time production possible and avoid the need



Zellstoff Pöls manufactures kraft papers for food packaging, carrier bags, gift wrap, and medical applications on the basis of as many as 180 specifications.

With the new 100-meter-long machine, which was supplied and installed by ANDRITZ PULP & PAPER, flexibility in kraft paper production will no longer be a problem for Zellstoff Pöls. The machine uses state-of-the-art technology and is fitted with the world's largest Yankee steel dryer. This guarantees that the paper is very strong, smooth, and glossy and allows for rapid changes between different grammages from 28 to 120 grams per square meter.

180 different papers

Zellstoff Pöls is one of the largest European producers of long fiber pulp and manufactures around 410,000 tons per year. Until now, the company has had a small paper machine producing around 14,000 tons of special papers, but its aim was to significantly increase its capacity and the number of different types of paper it could produce. Tomas Nölle, ANDRITZ Vice President Paper and Board,

to keep large quantities of products in stock. "The change from one type of paper to another had to be completed in a very short time, in order to keep waste production and energy consumption to a minimum and to maintain a high level of efficiency," says Nölle.

All of ANDRITZ's main competitors were involved in the tender process. Orders for machines of this kind are very rare and even more unusual are complete mills covering the entire process from stock preparation to the paper machine, including automation and stock pumps.

"We knew that this project was tailor-made for us," explains Michael Pichler, Head of the ANDRITZ Pulp Drying and Paper division. "We had been looking for an opportunity to put into practice our latest and most innovative design concepts in a new paper machine. From a strategic perspective, it was very important for us to build a reference machine in Europe, which is our main market."

Zellstoff Pöls, on the other hand, wanted a partner with “decades of experience in the pulp and paper industry and the ability to supply a complete plant with very low energy consumption and high drying efficiency,” according to Siegfried Gruber, Head of Project Engineering at Zellstoff Pöls.

The two companies’ aims were well matched and the concept proposed by ANDRITZ for the huge “multitasking” machine so impressed Zellstoff Pöls that it signed the contract with ANDRITZ in May 2012. This was the start of a design race right across Europe that did credit to the flying rhino. The timeframe was very short – just 14 months. ANDRITZ started the machine after exactly 13 months and ten days, which also represents a record.

This was not only possible because of the perfect cooperation between Zellstoff Pöls, ANDRITZ, and the suppliers but also because ANDRITZ was able to make use of its own resources network from all over Europe. The ANDRITZ headquarters in Graz, almost 100 kilometers from Pöls, managed the project, together with ANDRITZ Küsters in Krefeld, Germany. ANDRITZ in Italy was involved in the design process and ANDRITZ in Finland supplied the stock preparation system. ANDRITZ in Hungary constructed the Yankee dryer, which plays a crucial role in ensuring that the paper is smooth and glossy. The cylinder is the largest ever made. It weighs 150 tons and has a diameter of 6.7 meters and a shell length of 6.3 meters.

“This project represented a huge challenge, which we were only able to overcome so quickly and successfully because we worked together very well across several countries,” says Robert Duschnig, Technical Director at ANDRITZ in Tiszakécske, Hungary. “We are very proud to have contributed the world’s largest Yankee dryer.”

High-precision work for the biggest Yankee cylinder in the world

The cylinder was transported in two parts on heavy-duty trucks along the 550-kilometer route from Hungary to Pöls. The journey was a major logistical challenge; tunnels had to be completely closed, bridges measured, and roadways reinforced. In early June 2013, the two halves of the cylinder arrived in Pöls and were precision welded together on the construction site.

A few days before, a 600-ton crane had been erected next to the new mill building in Pöls, which was to lift the huge cylinder through the roof into the building. “We needed a completely windless day,” explains ANDRITZ Project Manager Stefan Wilms. “If 150 tons of cylinder began swaying, it would be impossible to lift it in through the roof without causing damage.” The opening of the roof’s concrete structure was only seven meters wide, which left just 30 centimeters of leeway.

Stefan Wilms remembers June 4, 2013, well – the dramatic day when the cylinder was attached to the special crane. The temperature had fallen to 14 degrees Celsius, dark clouds were scudding across the sky, and the flags on the crane were taut in the wind. Individual gusts were reaching force 3 to 4, which is equivalent to almost 30 kilometers per hour. “We couldn’t even consider

starting the lifting procedure. It would have been far too dangerous,” says Wilms. At around 5.00 in the afternoon, the project management team wanted to give up for the day and then the flags suddenly sagged. The wind had dropped. At 6.00 p.m., the crane driver began lifting the cylinder. “By 7.30 p.m., the cylinder had passed through the critical area in the factory roof and could finally be lowered,” explains Wilms. “You can imagine how relieved we were that the key component of the machine had been put in place safe and sound after the long journey and the delay.”

High-precision supply: The ANDRITZ cylinder is the largest ever made. It weighs 150 tons and has a diameter of 6.7 meters and a shell length of 6.3 meters.



The paper machine is now in routine operation, which means that it is producing up to 1,000 meters of paper every minute. The sheets pass through the machine at 60 kilometers per hour with fully automatic controls, acceleration, and braking. "We are already ten percent above the capacity that we had guaranteed to Zellstoff Pöls," reports Wilms. "And during 2015, the machine will probably produce more than the promised amount of 80,000 tons of special paper."

Kraft paper market to grow by 2-4% per year

The new paper machine is of strategic importance for the Zellstoff Pöls production facility in Austria. There are very few locations in Europe where kraft paper can be produced

as efficiently and sustainably. From a financial perspective, investing in special paper makes a lot of sense. In contrast to the market for newsprint and magazine paper, the Internet has resulted in hardly any competition for packaging materials. "The annual growth forecasts for the kraft paper segment are around two to four percent," says Werner Hartmann, Managing Director of Starkraft.

For Stefan Wilms, Pöls is a very important reference site. "It demonstrates our expertise in producing complete production lines. There are very few suppliers that could build a complete plant of this kind from the stock system to the slitter rewinder and in such a tight timeframe."

A precision landing for the flying rhino.

Michael Kneissler, Austria



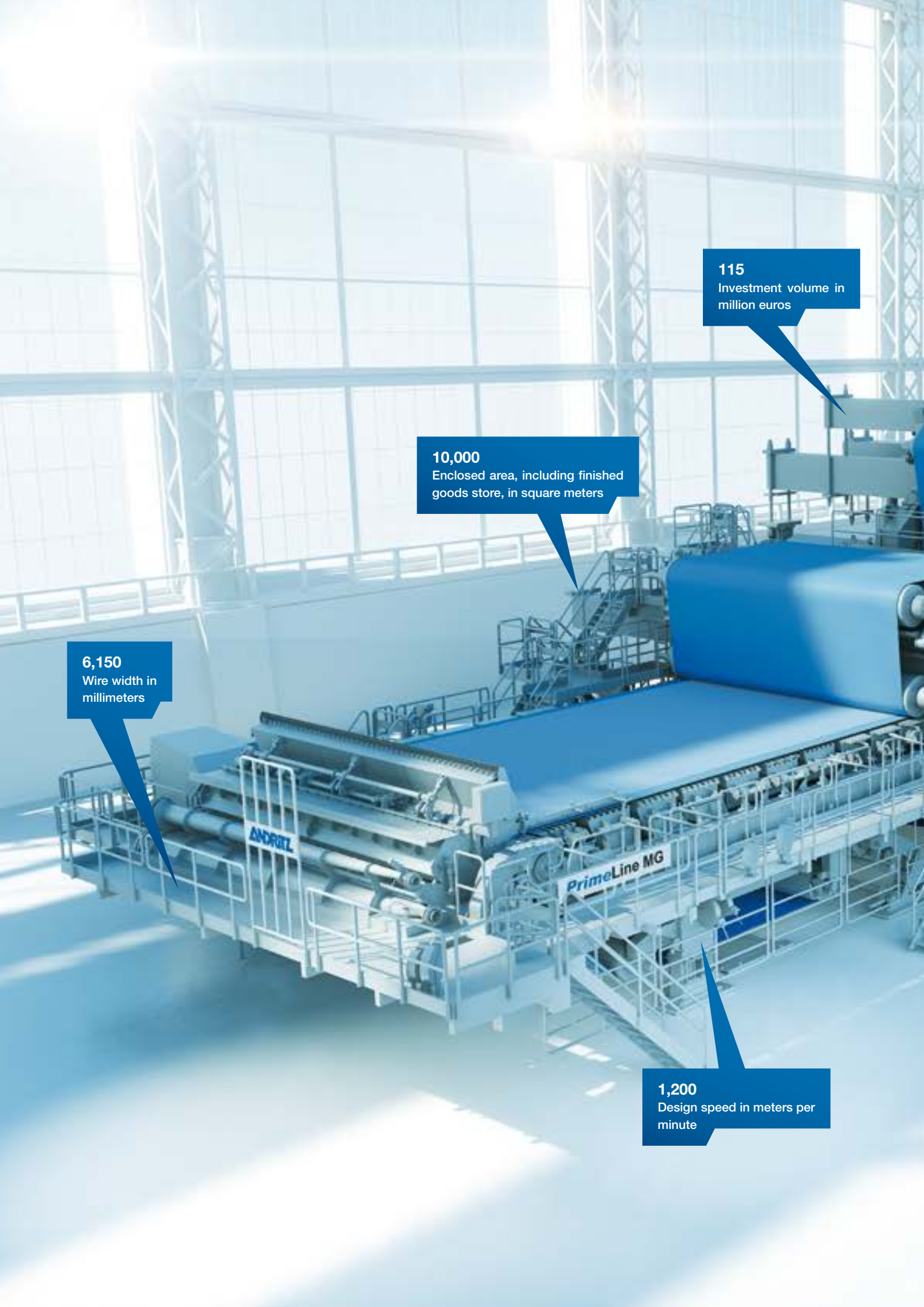

6,150
Wire width in
millimeters

10,000
Enclosed area, including finished
goods store, in square meters

115
Investment volume in
million euros

1,200
Design speed in meters per
minute

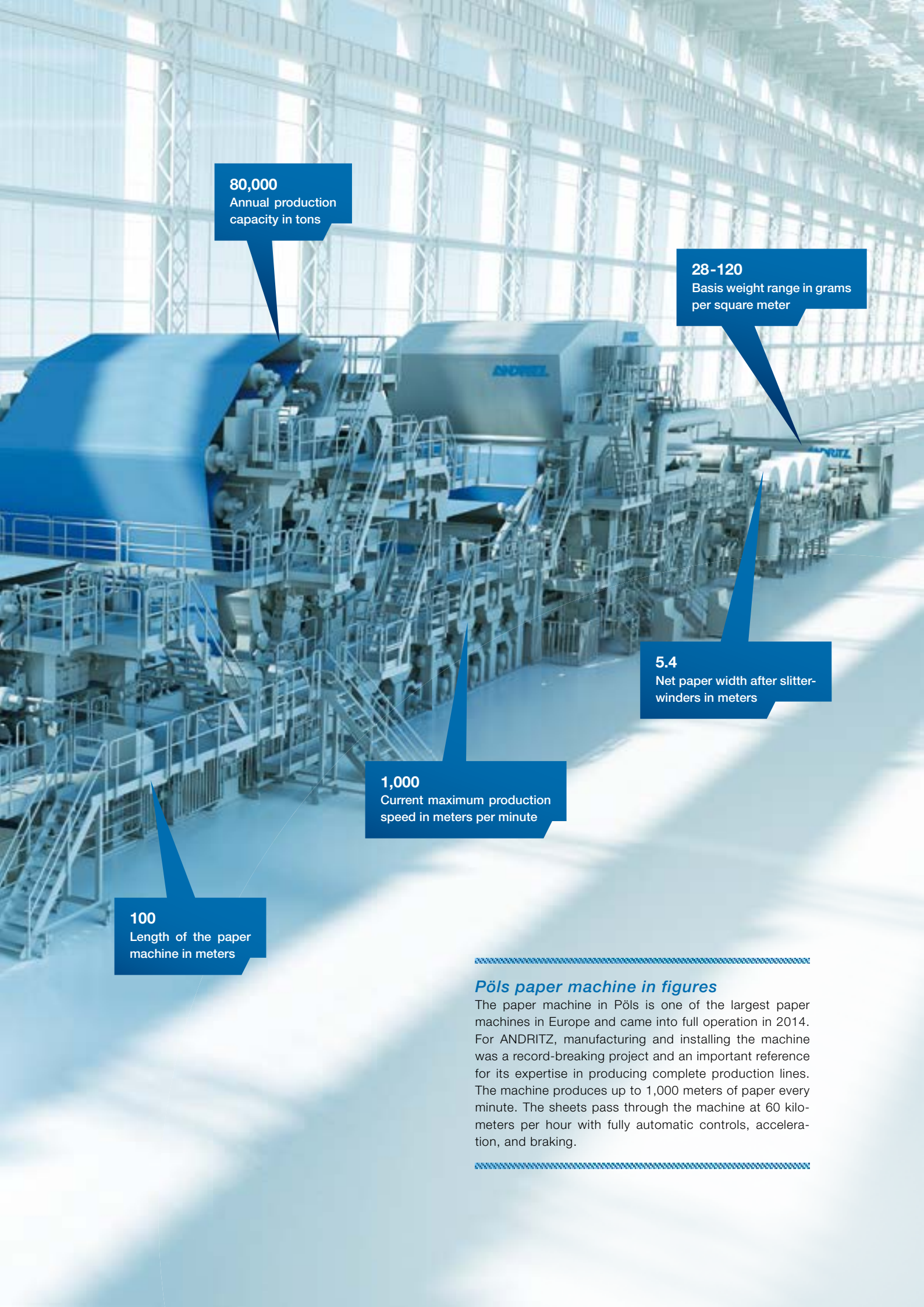

80,000
Annual production capacity in tons

28-120
Basis weight range in grams per square meter

5.4
Net paper width after slitter-winders in meters

1,000
Current maximum production speed in meters per minute

100
Length of the paper machine in meters

Pöls paper machine in figures

The paper machine in Pöls is one of the largest paper machines in Europe and came into full operation in 2014. For ANDRITZ, manufacturing and installing the machine was a record-breaking project and an important reference for its expertise in producing complete production lines. The machine produces up to 1,000 meters of paper every minute. The sheets pass through the machine at 60 kilometers per hour with fully automatic controls, acceleration, and braking.

Highlights 2014

Brazil's largest integrated pulp and paper producer counts on ANDRITZ

ANDRITZ received an order from Klabin, the largest integrated pulp and paper manufacturer in Brazil, to supply the woodyard, complete fiberline (for softwood and hardwood), and the white liquor plant at a new pulp mill in Ortigueira, Brazil. The project is the largest investment in Klabin's history and will double its production capacity – the pulp mill will have an annual production capacity of 1.5 million tons. The project is an important driver for the regional economy. Up to 8,500 new jobs will be created during construction work and more than 1,400 after start-up, which is scheduled for 2016.





Woodyard



Montes del Plata, the pulping company owned jointly by Stora Enso and Arauco, officially inaugurated its greenfield mill near Punta Pereira, Uruguay, in September 2014. The design capacity for the mill is 1.3 million tons of bleached eucalyptus pulp per year. ANDRITZ supplied key production lines, equipment, and technologies as shown here and was also responsible for civil construction, erection, commissioning, and start-up of these deliveries.



Evaporation plant



Recovery boiler



Fiberline



Pulp dewatering



Pulp drying plant



Automated baling lines



White liquor plant



Power boiler



Process pumps



Solutions for plant control, optimization, and simulation





Europe

The business area recorded the following important orders in Finland: at Stora Enso's Varkaus mill, the fiberline, recovery boiler, evaporation plant, recausticizing plant, and recycled fiberline are undergoing a rebuild. This includes conversion of the fiberline to produce unbleached pulp, an increase in capacity, and an improvement in efficiency of the evaporation plant. UPM-Kymmene placed an order for modifications to the Kymi mill's cooking and brownstock washing systems, and for delivery of a new pulp drying plant. UPM's Kaukas mill ordered the modernization of its lime kiln. Jyväskylän Energiantuotanto awarded ANDRITZ an order to rebuild its power boiler and add flue gas cleaning equipment to lower emissions.

Mondi ordered the rebuild of a recovery boiler at the Świecie pulp mill in Poland into a state-of-the-art biomass boiler, as well as the delivery of a green liquor filtration system as part of a modernization project for its mill in the Czech Republic.

Celulose de Cacia, Portugal, placed an order for the upgrade of a continuous cooking system and the retrofit of a drying machine.

ANDRITZ has been selected by the utility company Riikinvoima to supply equipment for the new **waste-to-energy power plant** in Leppävirta, Finland. The plant is designed to treat 145,000 tons of waste per year coming from eight local waste management companies. The design capacity is 16 megawatts for electricity and 38 megawatts for district heating. The efficiency of ANDRITZ's equipment and technology to enhance environmental protection was decisive in the award of this order.

International Paper, France, ordered the supply of an oxygen delignification system and a Drum Displacer (DD) washer for a modernization project at its Saillat mill.

Smurfit Kappa, Sweden, selected a new ANDRITZ debarking drum as part of a woodroom modernization project. Also in Sweden, Metsä Board ordered the rebuild of two existing drying lines.

For Estonian Cell, Estonia, a screening system will be upgraded to improve fiber quality and increase throughput.

Zellstoff Pöls, Austria, awarded an order to refurbish a black liquor recovery boiler. Also in Austria, Mondi Frantschach selected the business area to upgrade its fiberline equipment. In addition, the business area will supply a cooling and heat recovery plant as part of an order placed through ANDRITZ METALS (supply of a new walking beam furnace) by voestalpine Schienen.

Treofan, Germany, ordered a complete line for the production of five-layer BOPP (Biaxially Oriented Polypropylene) film. Mercer International ordered an upgrade to increase capacity at its evaporation plant in the Stendal mill.

A pressurized refining system, chipper, and chip washing systems will be supplied to Starwood Orman Ürünleri Sanayi, Turkey.

Important start-ups in Europe included the following: in Germany, the rebuild of a screening system for deinked pulp was completed for Leipa Georg Leinfelder and the modernization of RWE Power's flue gas desulfurization plant in Niederaussem was finalized successfully. Karlstad



Energi, Sweden, started up a new bubbling fluidized bed boiler, fueled with biomass, at its combined heat and power plant. Also in Sweden, the ANDRITZ-supplied biomass power boiler island for Växjö Energi's new combined heat and power plant went into operation, and the fiberline modernization for Stora Enso's Skoghall mill was started up. Mondi SCP, Slovakia, started up a new ANDRITZ High Energy Recovery Boiler (HERB), a new lime kiln, and a retrofitted evaporation plant. Modernization of the fiberline at Stora Enso's Oulu mill, Finland, was completed. Mondi Štětí, Czech Republic, and Naberezhnye Chelny, Russia, started up paper machines with ANDRITZ equipment. Also in Russia, Mondi Syktyvkar started up a new pulp drying machine. Pressurized refining systems for MDF production went into operation at Kastamonu Integrated Wood Industry and Trade, Russia, and AGT Agac Sanayi ve Ticaret, Turkey.



North America

In the USA, a customer ordered a recovery boiler to replace three existing recovery boilers and make the pulp mill energy self-sufficient. The same customer also ordered a seven-effect, high-solids evaporation plant. Weyerhaeuser ordered the retrofit of a recovery boiler at its mill in Flint River, Georgia. As part of this order, ANDRITZ will deliver a flue gas cooler that will help the mill recapture and reuse otherwise wasted energy. Oklahoma Gas & Electric Company selected ANDRITZ to supply a circulating scrubbing air pollution control system for two 569-megawatt coal-fired boilers. Clearwater Paper, Arkansas, started up its lime kiln after ANDRITZ completed modernization work.

In the panelboard industry, Dieffenbacher ordered a pressurized refining system to be installed at PRO MDF's plant in Mexico.



South America

In Peru, Papelera Reyes ordered an upgrade to its deinked pulp system for tissue production to include pulping, screening, cleaning, and process pumps.

In Brazil, Suzano Imperatriz selected the business area to provide optimization services for the fiberline of a pulp mill. CTC started up an ANDRITZ pretreatment system for the conversion of sugar cane bagasse to ethanol.



Asia

In Indonesia, OKI Pulp & Paper Mills placed an order for supply of the world's largest recovery boiler. At 11,600 tons of dry solids per day, the capacity of this recovery boiler is about 50% higher than of any other recovery boiler operating today. OKI also ordered the world's largest chipping plant, consisting of nine chippers with log loading

decks, feed systems, and discharge systems. Also in Indonesia, P.T. Mekabox International will take delivery of an OCC (Old Corrugated Containers) processing line, and at PT. Indah Kiat Pulp & Paper, the fourth of six stock preparation and paper machine approach systems for new tissue machines went into service.

The following important orders were booked in China: Stora Enso Packaging ordered a complete wood handling line for a greenfield mechanical pulp plant and board machine. The stock preparation and paper machine approach processes at Shandong Sun Paper Industry are to be rebuilt and modernized. In order to convert a machine from fine paper to food-grade packaging papers production, Sun Paper Industry ordered new ANDRITZ stock preparation and paper machine approach systems. Guangdong Shaoneng Group ordered a new tissue machine with steel Yankee, stock preparation, and automation equipment. After the recent start-up of the first machine in 2014, Hebei Yihoucheng ordered a second ANDRITZ tissue machine with steel Yankee, stock preparation, and automation. Zhanjiang Chenming Pulp & Paper ordered a 65-megawatt gasification plant to generate green fuel gas from biomass to fire the mill's lime kiln. Dalian Ruiguang Nonwoven Group ordered a complete high-speed wetlace nonwovens line. The ANDRITZ technology enables manufacturing of a great variety of products, such as biodegradable (flushable) nonwoven wipes without any chemical binder. The most successful start-ups in China include those for Liansheng Paper (production lines for recycled fiber, kraft fiber, deinked pulp, and paper machine approach), Jiangsu Xinyuan Reconstituted Tobacco and C&S Paper Yunfu (stock preparation and paper machine approach systems), Hebei Yihoucheng Commodity and Shandong Sun Paper Industry (tissue machines with steel Yankees and stock preparation equipment), Hunan Hengan Living Paper Products (tissue machine, stock preparation, automation), and Yuanjiang Paper (start-up of a production line for mechanical pulp in record time: it took only 16 hours from the first chips to the production of quality fiber).

Middle East Paper, Saudi Arabia, selected ANDRITZ to rebuild three paper machines in order to improve quality and increase capacity.

In Thailand, Siam Kraft Industry (SGP Paper) ordered the rebuild of a production line for processing OCC and old newspapers, as well as the approach system for a board machine and a green liquor semi-chemical pulp fiberline.

Danalakshmi Paper Mills Private, India, ordered the rebuild of an existing deinked pulp line to improve stock quality.

There were several orders in the panelboard sector, including the supply of a pressurized refining system to MDF VRG Quang Tri Wood, Vietnam.

Following extensive modernization and rebuild work at Oji Paper, Japan, a fiberline and sheet drying plant for dissolving pulp production went into service successfully.





Profile

ANDRITZ METALS is technology and global market leader in metalforming via the Schuler Group, in which ANDRITZ has a stake of more than 95%. Schuler offers presses, automation solutions, dies, process know-how, and services for the entire metalworking industry. Its customers include car manufacturers and their suppliers, as well as companies in the forging, household equipment, packaging, energy, and electrical industries. Schuler is also the market leader in coin minting technology and offers system solutions for the aerospace and railway industries. In addition, ANDRITZ METALS is one of the leading global suppliers of complete lines for the production and processing of cold-rolled strip made of stainless steel, carbon steel, aluminum, and non-ferrous metal. The lines comprise equipment for cold rolling, heat treatment, surface finishing, strip coating and finishing, punching and deep drawing, and for the regeneration of pickling acids. The business area also supplies turnkey furnace systems for the steel, copper, and aluminum industries, as well as welding systems for the metalworking industry.

Market development 2014

International project activity in the metalforming sector, especially for the automotive and automotive supplying industries, was good during the reporting period. While investment activity in Europe remained at a satisfactory level, several large orders were awarded by international car manufacturers and their suppliers, particularly in China. As a result of the continuing overcapacities in

the international steel and stainless steel industries as well as the weak demand due to the overall economic situation, project activity for plants and equipment for the production and processing of stainless steel, carbon steel, and non-ferrous metal strip continued to be low. However, good investment activity was noted in the aluminum industry.

Market data

Automotive market in the overtaking lane

Slow but steady is the best description of the growth in the worldwide automotive market. In 2013, more than 80 million vehicles were produced around the world, which is roughly 25% more than ten years ago. Market estimates indicate that already by 2018 for the first time 100 million cars and light trucks will roll off the production lines. The largest growth market is China, which is the world's biggest vehicle manufacturing nation and which produced more than 19 million vehicles in 2013, followed by Europe (including Russia and Turkey), North America, Japan, and Korea.

Global production volume in million car units*

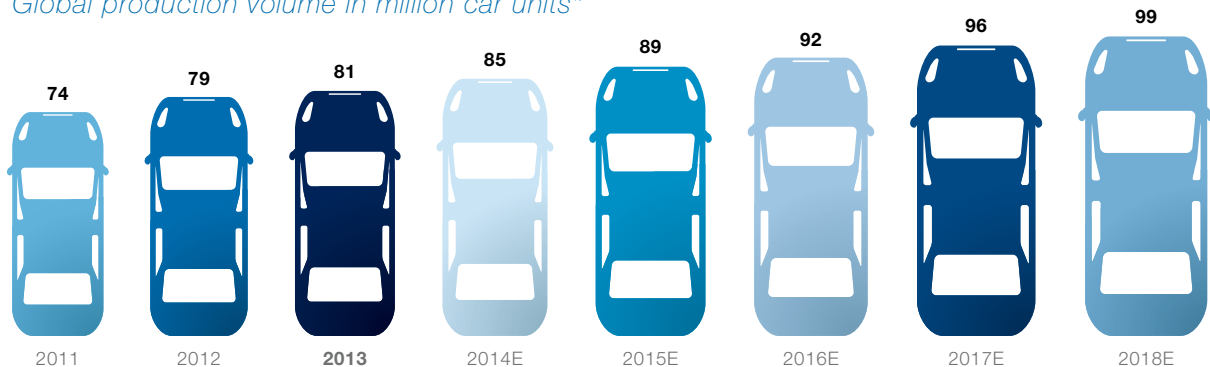

Regional share of worldwide car production in 2013 / expected annual average growth rate 2013-2018*

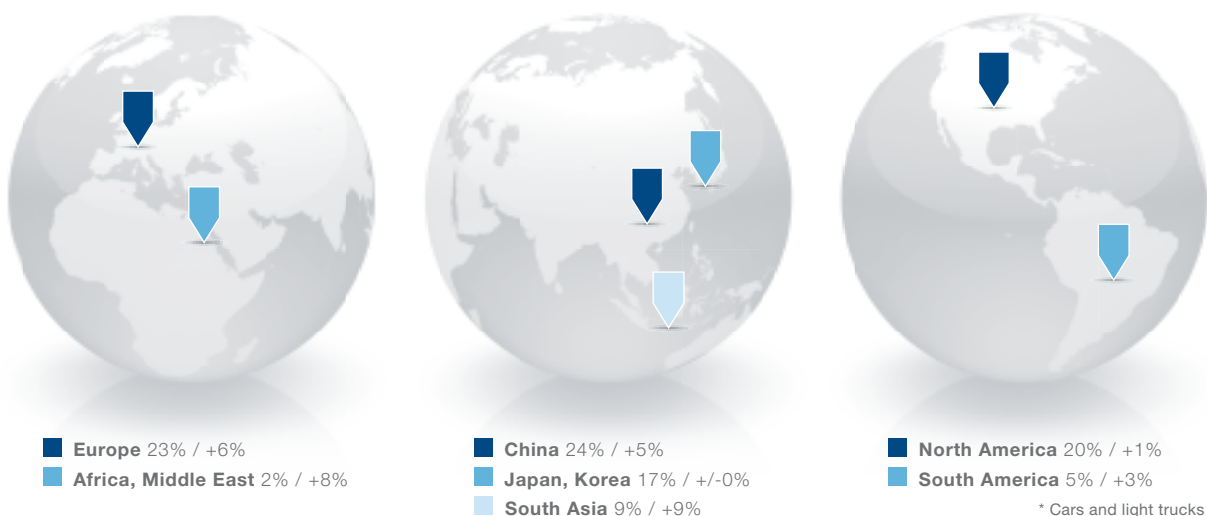

Source: IHS Automotive/R. L. Polk



Aluminum – a material with a promising future

Aluminum has a high specific strength. Aluminum components with the same strength as steel weigh half as much, but have a larger volume. This makes the material ideal for applications where a low mass and light weight are required, for example in the automotive, aviation, shipping, construction, and packaging industries. In 2013, the global consumption of aluminum was 46 million tons. Market experts predict that this will almost double up to 89 million tons in 2023. The largest growth is forecast in the transport, construction, and packaging industries.

Aluminum consumption 2013 versus 2023 by industry (in millions of tons)

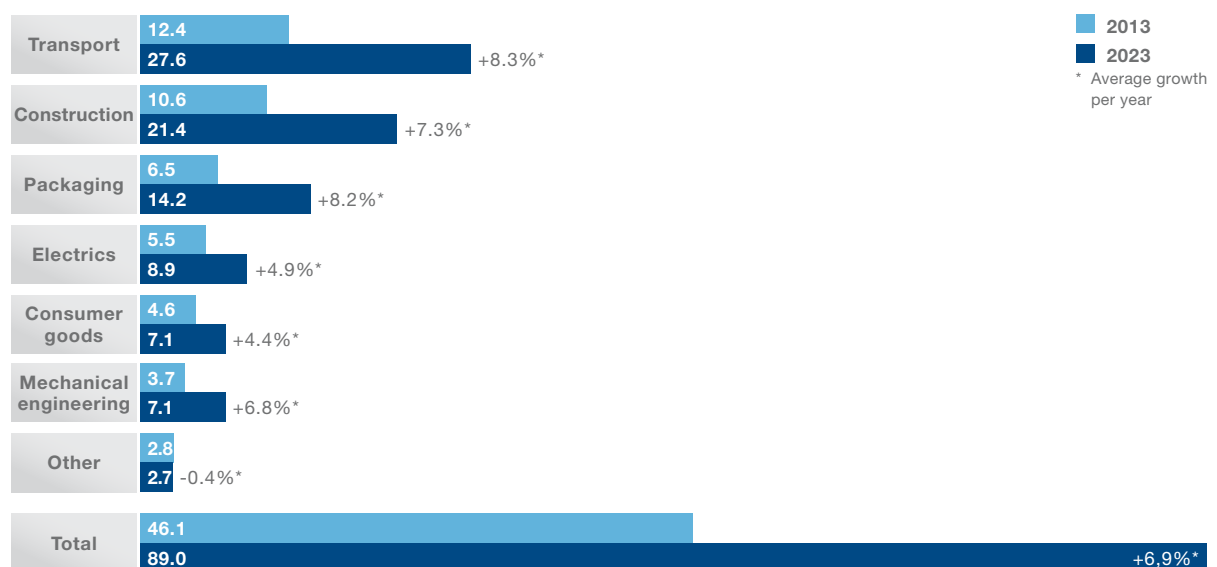

By far the most significant aluminum-producing country is China, which had a market share of 45% in 2013. In distant second place is the USA with a market share of 10%, followed by the rest of Asia with 7%. Market experts expect these rankings to remain unchanged in 2023, but they estimate that China will by then have a market share of 56%, while the USA, as the second largest producer of aluminum, will have a share of 8%.

Source: Visiongain

Governments all over the world have set ambitious targets for CO₂ reduction. One way of achieving these goals will be to build lighter cars. The USA and the European Union, for example, have already introduced significant reductions in CO₂ emissions for new cars and Canada and China have announced similar targets.

Source: International Council on Clean Transportation

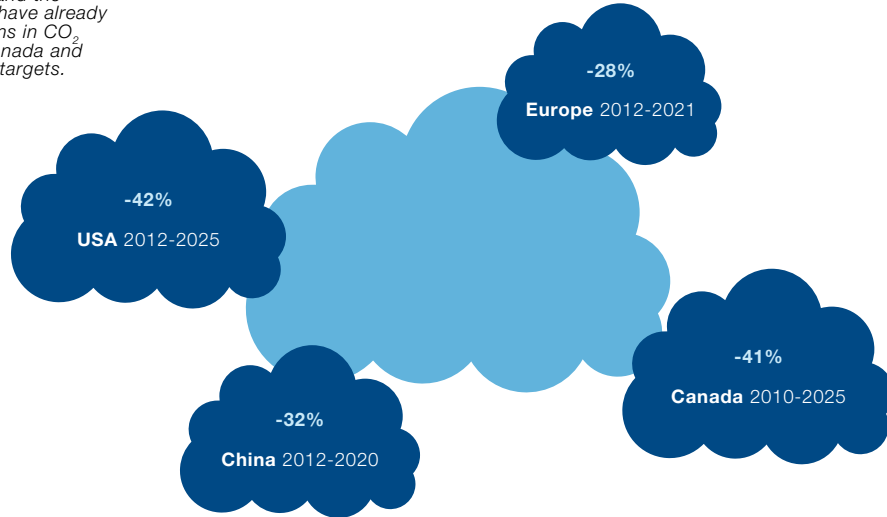

The challenge:
future and innovation

Traveling light

Modern cars are no longer made just from steel sheet, but from a complex mix of materials. This makes them not only lighter in weight and more environmentally friendly, but also even safer. ANDRITZ is the only manufacturer in the world to offer solutions for all important light-weight construction processes for manufacturing lightweight components made from higher strength steels, aluminum, and carbon fiber.

*The future of car manufacturing:
lighter, more environmentally
friendly, and safer.*

Every now and then one glides past you on the road and, yes, the BMW i3 is certainly eye-catching. There are good reasons for this: the design, the electric drive, and also other features that are not obvious to the naked eye. For example, its light weight, which many of us will have heard about. The entire passenger compartment is manufactured from carbon-fiber-reinforced plastic (CFRP) with a very high tensile strength. If it were made from conventional steel, the car would weigh almost 300 kilograms more.

Although the first cars were built around 125 years ago, many of the latest vehicles, like the BMW i3, demonstrate that the automotive industry is in one of the most exciting phases of its development, because the individual transport solutions of the future present major challenges. Vehicle manufacturers are looking for new ways of enabling our vehicles to continue transporting us to work or on vacation quickly, safely, comfortably, and with a low environmental impact, in an era of rising volumes of traffic and ambitious CO₂ limits. And, of course, driving pleasure is another important factor.

For this reason, technical innovations will be an essential feature of vehicle design and manufacturing. The materials must be safe, flexible in their application, and most importantly light in weight, for example to compensate for the heavy batteries used in electric and hybrid cars. The lighter the cars, the longer their range. For combustion engines, the general rule of thumb is that a 100-kilogram weight reduction cuts fuel consumption by up to 0.6 liters per 100 kilometers and also lowers CO₂ emissions accordingly. For a car manufacturer that sells hundreds of thousands or even millions of new cars each year, this represents a huge amount of untapped potential, which will allow it to ensure that its fleet of vehicles meets the stringent CO₂ limits of the future.

Intelligent lightweight design

ANDRITZ is a partner to the automotive industry, enabling its customers to exploit the extensive strategic and financial potential of lightweight design: a partner with the necessary wide-ranging knowledge and experience to harden, press, and weld steels, aluminum, CFRP, and other modern material mixes safely and efficiently all over the world.

Lothar Gräbener, Sales Manager for hydraulic presses at Schuler, which joined ANDRITZ in 2013, still has strong memories of the period before the start of

the new millennium, when galvanized steel was the standard material used for vehicle manufacturing. The weight of cars was not a high priority. "Bodies were made almost exclusively from relatively soft, cold-formed steel sheet," he says. "Today, in contrast, we are working with a wide variety of materials that are as light and as stable as possible: high-strength steels that are cold-formed or produced by hot forming, together with aluminum and CFRP, like those used in the BMW i3."

Modern vehicle bodies represent a huge and challenging puzzle. Car manufacturers examine every component meticulously from the perspective of its function, weight, cost, and integration into the existing production process. Then they decide which material can most effectively be used for each part. "The solution is to make use of the right material in the smallest possible quantity in the right place in the car," says Frank Schieck from the Fraunhofer Institute for Machine Tools and Forming Technology IWU in Chemnitz, Germany. This means that composite structures are becoming increasingly common. "Manufacturers are focusing on improved material usage in order to

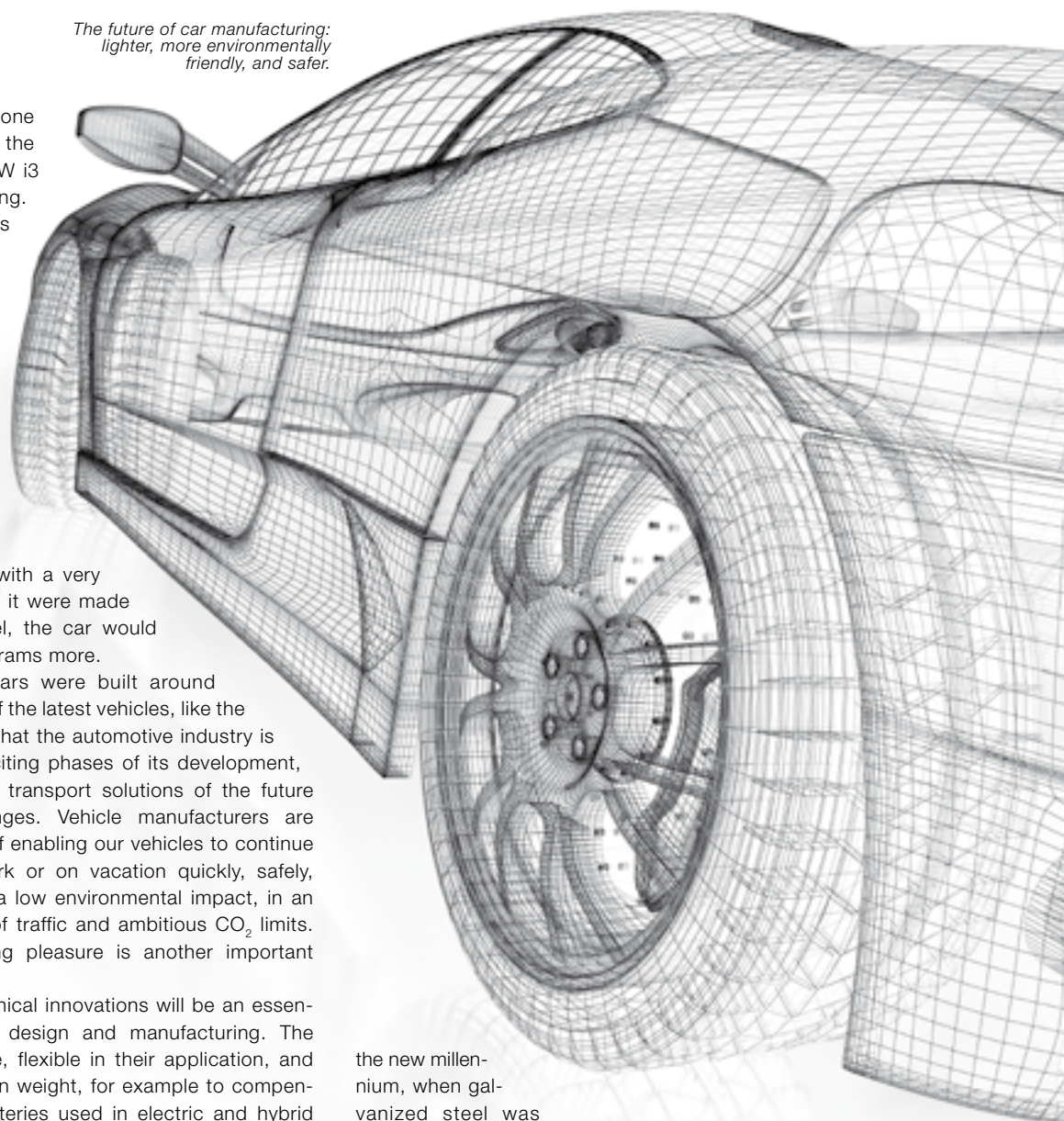

„ANDRITZ isch weltwiit
's einzige Unternehme,
wo alli wichtige Verfahre im
Automobilliechtbau
us einere Hand
chan liefere. De Markttrend isch klar:
D' Auto
müend liechter und
glichenzeitig stabiler werde.“



**Domenico Iacovelli, Managing Director
of ANDRITZ Soutec, Switzerland:**

*“ANDRITZ is the only company in the world that can supply
all the important processes for manufacturing lightweight
components for the automotive industry from a single source.
Market trends clearly indicate that in future cars will have to
be lighter in weight and, at the same time, more stable.”*

reduce trimming and waste,” adds Frank Schieck. Other important factors include cutting the energy consumption of the production process and increasing the recyclability of the materials.

A hot option

One hot option in this context is high-strength steel formed at temperatures of up to 950 degrees Celsius. Hot forming, also called press hardening, increases the tensile strength of steel significantly, which allows the thickness of the steel sheet to be reduced accordingly. This makes it possible to manufacture very thin, extremely strong components, which, depending on their purpose, can be made into a wide variety of shapes. In the current VW Golf VII, for example, twelve of these hot-formed parts are being used for the first time in the car’s substructure. This is twice as many as in the whole of the Golf VI. The consequences for the car’s overall weight are considerable. For the first time in the history of the Golf, the current model range is lighter than its predecessor.

“This model is setting new standards,” says Lothar Gräbener with conviction. The worldwide trend is growing. “We estimate that the number of hot-formed parts in the automotive industry will increase from the current annual figure of 200 million to up to 650 million by 2017.” At the start of 2014, there were 195 production lines for hot forming throughout the world, 60 of which were supplied by world market leader Schuler. By the end of 2017, there are likely to be around 300 lines in use worldwide.

Schuler is also keeping pace with the latest trends in other areas, including hot and cold forming, aluminum forming, plastic forming, and hydroforming. The company can respond flexibly to the individual requirements of its customers from the automotive and metalworking industries. “We are the only manufacturer in the world to cover all the most important processes for manufacturing lightweight components,” says Lothar Gräbener. Among other things, the company produces complete manufac-

turing lines: “Including factory and plant planning, tools, employee training, and production support,” explains Lothar Gräbener. For example, Schuler is providing automotive supplier voestalpine with four new hot forming lines for various locations throughout the world and is also supplying car manufacturer Proton with similar lines in Malaysia. Customers from China have already indicated their interest in solutions of this kind.

Innovative welding processes

Before vehicle bodies and external parts are formed and pressed, they can also be jointed in different ways. Welding is a widely used process for this purpose and indicates the rapid speed with which innovations are introduced in the automotive industry. ANDRITZ is often responsible for setting the pace of change.

One example is that of ANDRITZ Soutec, one of the world’s leading suppliers of equipment for laser welding tailored blanks. More than 130 plants supplied by ANDRITZ Soutec are in use throughout the world by steel manufacturers, automotive industry suppliers, and car manufacturers. “There is still a great deal of potential to be exploited,” says Managing Director Domenico Iacovelli. ANDRITZ Soutec uses a new patented process for welding sheet metal that can be hot formed. Customers’ existing systems can be upgraded on site. “Our process enables the bodywork components to be made thinner and therefore lighter, while at the same time increasing their strength and stability,” explains Iacovelli. Honda has put the new system to the test. In its Acura MDX model, which is primarily intended for the US market, the blank for the door frame consists of sheet metal components that are welded together. The result is a weight reduction of 20% and above-average performance in crash tests. This has attracted the attention of other vehicle manufacturers, including Chrysler, which will be using a development of the ANDRITZ Soutec process in its future Voyager model.



In order to enhance safety, press-hardened components are used in car bodies: softer components to absorb the impact energy (black) and rigid components for a stable passenger compartment (red).
Photo: ArcelorMittal

Aluminum made in the USA

Before a material can be formed and welded, it must be processed and hardened to ensure that it has the correct chemical properties and the appropriate thickness, strength, and bendability. ANDRITZ METALS supplies the machines for this purpose. Because it weighs only around one third as much as conventional steel and is also exceptionally strong and easily recyclable, aluminum is being increasingly widely used. Wheel rims and engine blocks have been made from aluminum for many years, but it is now one of the main choices of material for body-work components, such as doors and pillars, or, as once demonstrated by Audi's flagship A8 model, for an entire space frame.

"We are seeing a real boom in North America," says Heinz Autischer, Head of ANDRITZ METALS. Ford, for example,

will in future be making much greater use of aluminum in its popular F-150 off-roader. The truck is much lighter than before, also because of hydro-formed parts made on Schuler lines. Currently the automotive industry in the USA and Canada processes around half a million tons of aluminum each year. In the next ten years this figure is

High-strength steel is formed at temperatures of up to 950 degrees Celsius (the photo shows a Schuler plant). This increases the tensile strength of steel significantly, which allows the thickness of the steel sheet to be reduced accordingly. This makes it possible to manufacture very thin, extremely strong components, which, depending on their purpose, can be made into a wide variety of shapes. In the current VW Golf VII, for example, twelve of these hot-formed parts are being used for the first time in the car's substructure. This is twice as many as in the whole of the Golf VI. The consequences for the car's overall weight are considerable. For the first time in the history of the Golf, the current model range is lighter than its predecessor.



likely to increase fourfold, according to estimates from the analysts of the Ducker Market Research Group. The sales figures for the production lines developed and built by ANDRITZ are likely to be correspondingly good. "Three to four new plants will be built each year in North America up to 2020," explains Autischer.

But this is not only about quantity. The quality standards are also constantly rising. Innovation is therefore essential. For example, Alcoa 951 is an impressive new process recently presented by aluminum manufacturer Alcoa. It is a patented chemical process for pre-treating aluminum,

which makes the metal considerably more durable and easier to handle during production. Alcoa 951 was recognized by the prestigious US magazine "R&D" as one of the 100 most innovative technologies of 2013. ANDRITZ has played an important role in this development, because it supplies the machinery for the new treatment for aluminum sheet. For Heinz Autischer and his team this is a reason for celebration, but above all an incentive: "ANDRITZ will be attempting to ensure that the fast pace of innovation within the automotive industry continues unchanged in future."

Peter Gaide, Germany

By 2025, annual sales in the market for automotive lightweight will grow to almost 100 billion euros

Almost three million tons of lightweight materials were used in vehicle bodies in 2012, but market experts estimate that in ten years the figure will grow to approximately 16 million tons. The volume of sales will increase fivefold from around 20 to almost 100 billion euros. All the regions of the world will see significant growth. By 2025, it is likely that Europe will remain the largest market at 27 billion euros, closely followed by China (26 billion euros), where, together with Southeast Asia, the fastest growth rates are expected.

Worldwide market for lightweight materials¹ in the automotive industry



Regional sales development for lightweight materials 2012 versus 2025 in billions of euros²

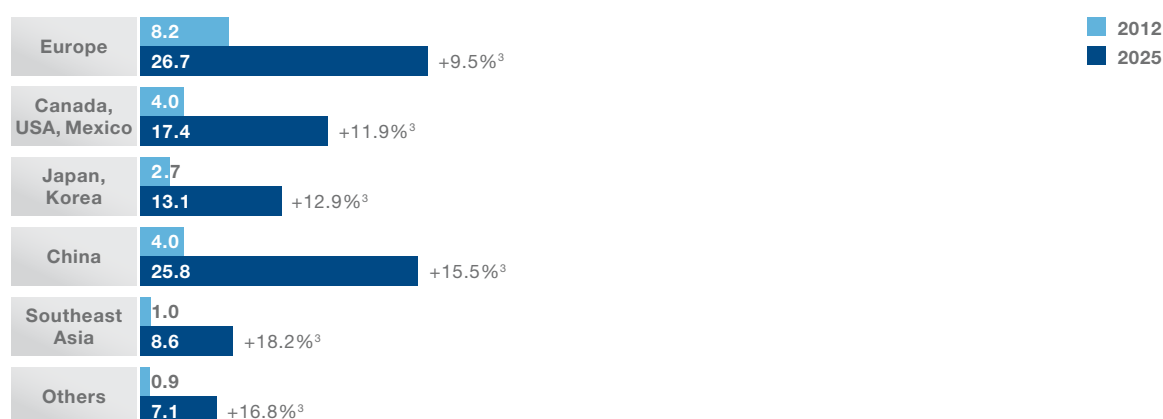

¹ Lightweight materials for vehicle bodies: high-strength steels, aluminum, magnesium, carbon-fiber-reinforced plastic, other plastics

² Regions correspond with production locations

³ Average annual growth rate

Source: Berylls Strategy Advisors

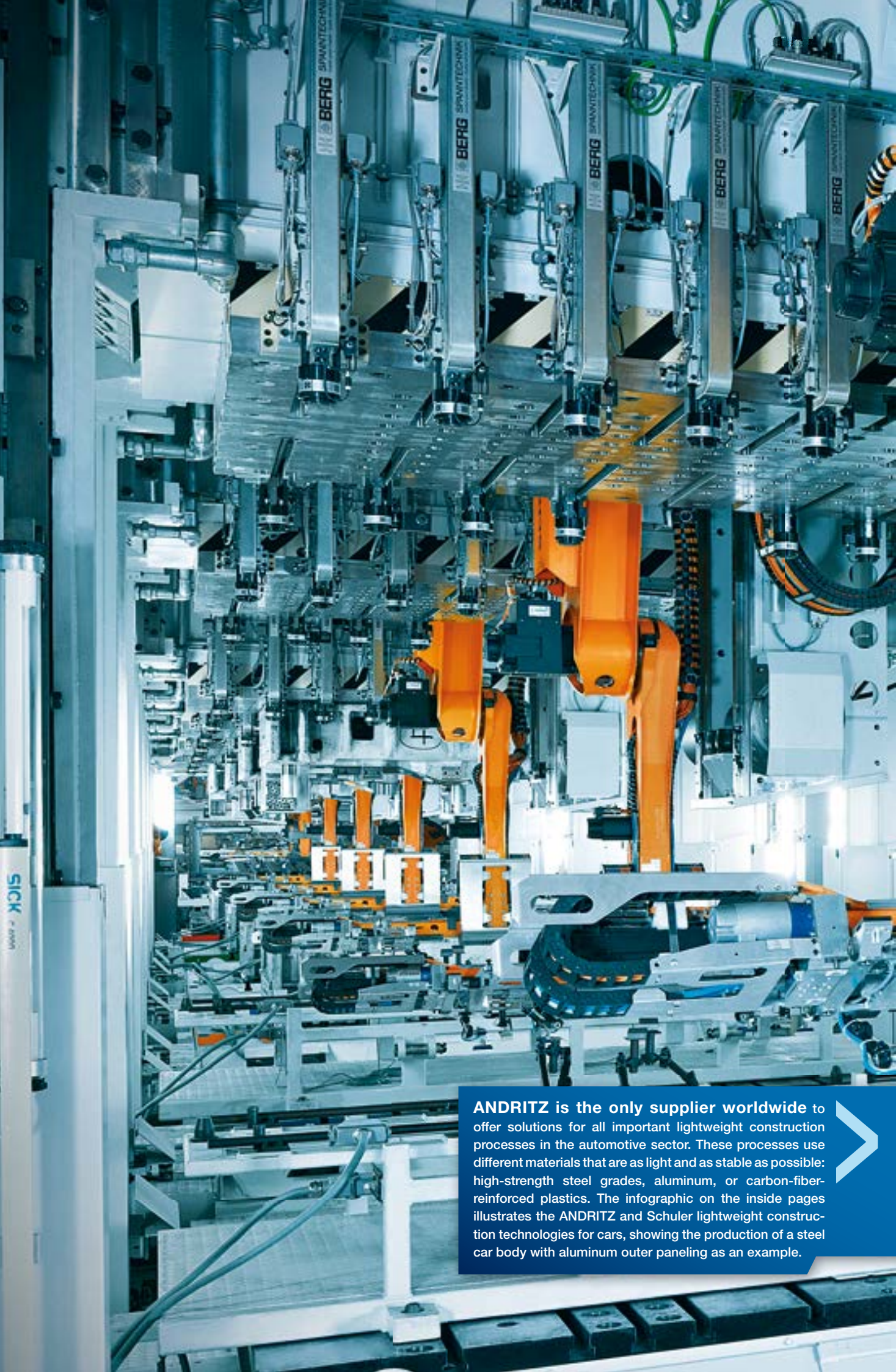

ANDRITZ is the only supplier worldwide to offer solutions for all important lightweight construction processes in the automotive sector. These processes use different materials that are as light and as stable as possible: high-strength steel grades, aluminum, or carbon-fiber-reinforced plastics. The infographic on the inside pages illustrates the ANDRITZ and Schuler lightweight construction technologies for cars, showing the production of a steel car body with aluminum outer paneling as an example.

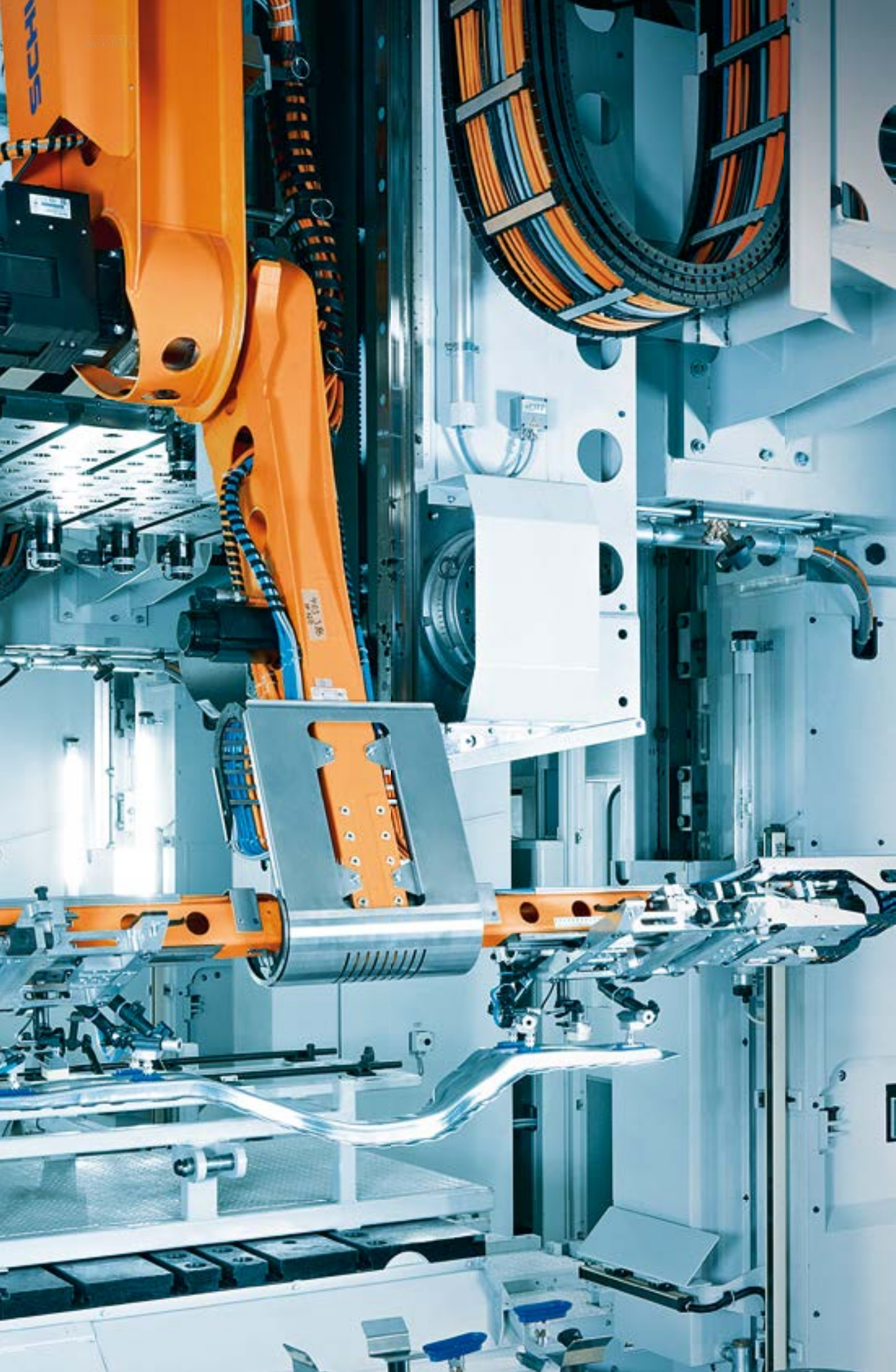

Lines for cold-rolled aluminum strip

From cold-rolled strip to automotive components ready for mounting: ANDRITZ METALS supplies solutions for the entire process chain in the automotive industry from a single source. The demand for aluminum has risen sharply in the past few years because the light metal reduces the weight of the vehicle, thus lowering fuel consumption. The equipment used in the first stage of processing aluminum includes plants for surface treatment as well as for strip coating and surface finishing in addition to rolling mills.

Surface treatment, for example, provides protection against corrosion or prepares the surface for subsequent varnishing. The chemical processes include degreasing, pickling, and applying conversion treating agents. So-called tension-levelers provide best possible flatness of the aluminum plate as a result of precise tuning between the tension and bending forces on the strip. For inspection purposes, flatness control systems are used in the form of measuring rolls with piezoelectric quartz crystals.

Blanking lines then divide the strip into individual metal sheets, known as blanks. Trapezoidal, curved, or other shapes can also be produced in addition to rectangles, depending on the application. The plants largely consist of the inlet section, washing equipment, precision-leveler, shears or blanking press, and vacuum sheet piler (magnetic sheet pilers are used for steel sheets). Multi-function lines for processing aluminum combine several process steps in one plant.

Laser welding

The laser welding plants from ANDRITZ Soutec can produce tubes and so-called tailor-welded blanks – blanks in which sheets of different material quality and thickness are welded to one another. This optimizes the component properties because there is no need for additional components to reinforce the bodywork, which in turn reduces the weight.

Assembly

ANDRITZ subsidiary Schuler offers three methods for producing automotive parts: plastic forming to manufacture the passenger compartment from carbon-fiber-reinforced plastic, cold and hot forming, and the hydroforming process. In this case, tubes are expanded from the inside out in a closed die by means of a water and oil mixture. This method makes it possible to produce hollow components with complex external geometry and special strength properties. Aluminum parts are mainly manufactured using the cold-forming method.

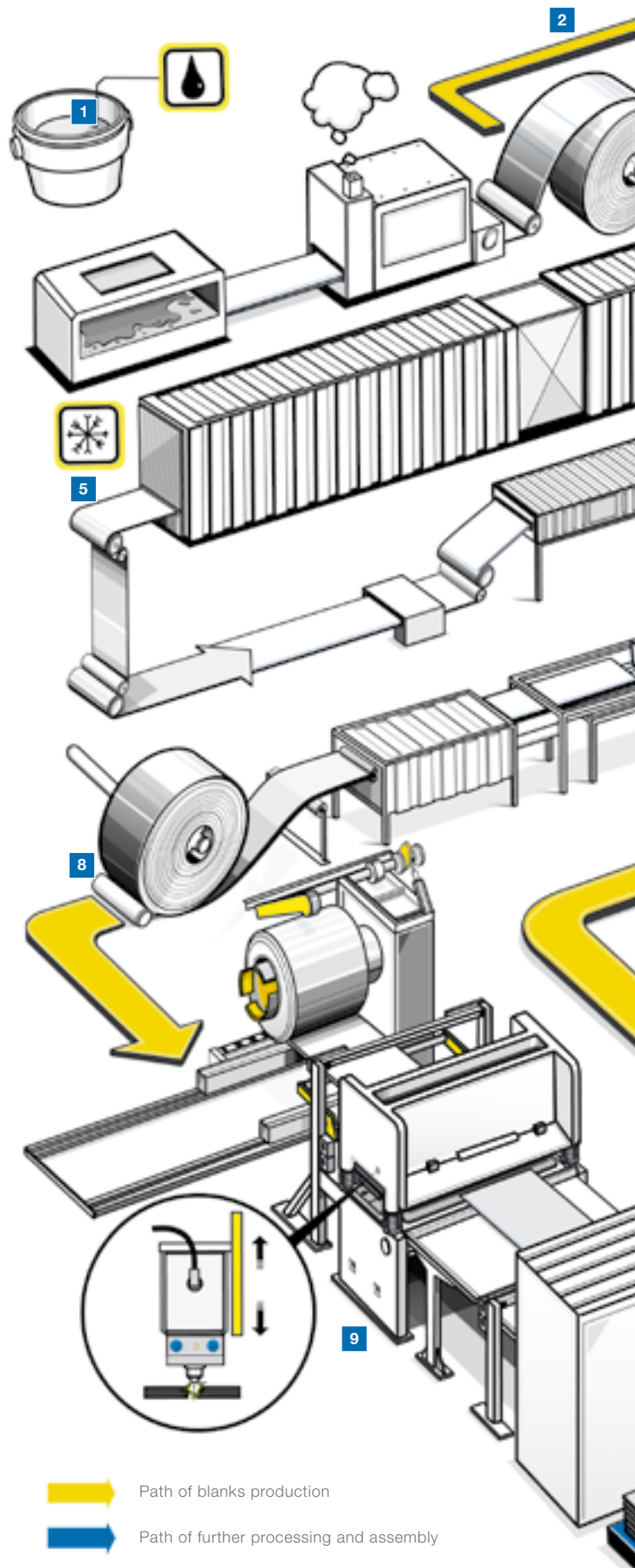

➔ Path of blanks production

➔ Path of further processing and assembly

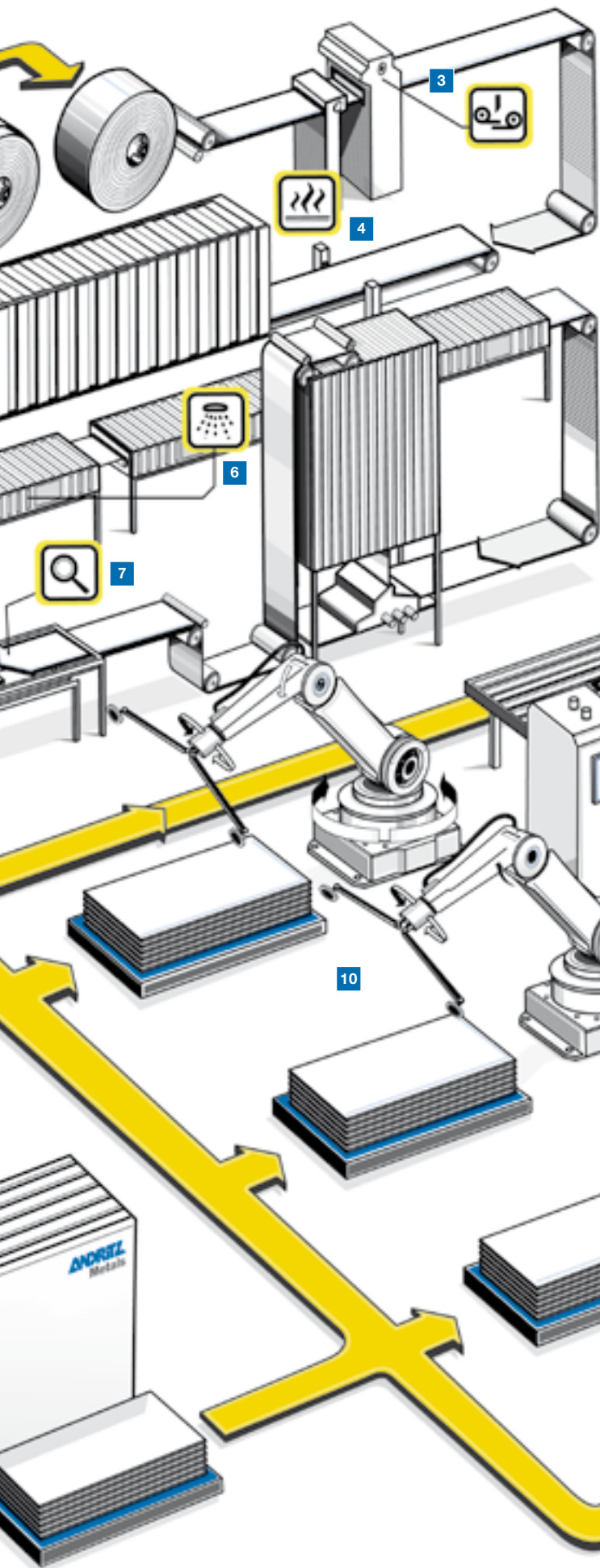

Lines for cold-rolled aluminum strip

- 1 Melting
- 2 Uncoiling, smoothing, and cutting
- 3 Joining (two coils) – tack welding and finish welding
- 4 Heating
- 5 Cooling
- 6 Chemical treatment, application of conversion treating agents
- 7 Inspection
- 8 Coiling
- 9 Cutting of blanks

Laser welding

- 10 Linear laser welding plant
- 11 Non-linear laser welding plant
- 12 High-performance laser welding plant
- 13 Laser welding plant for tubes

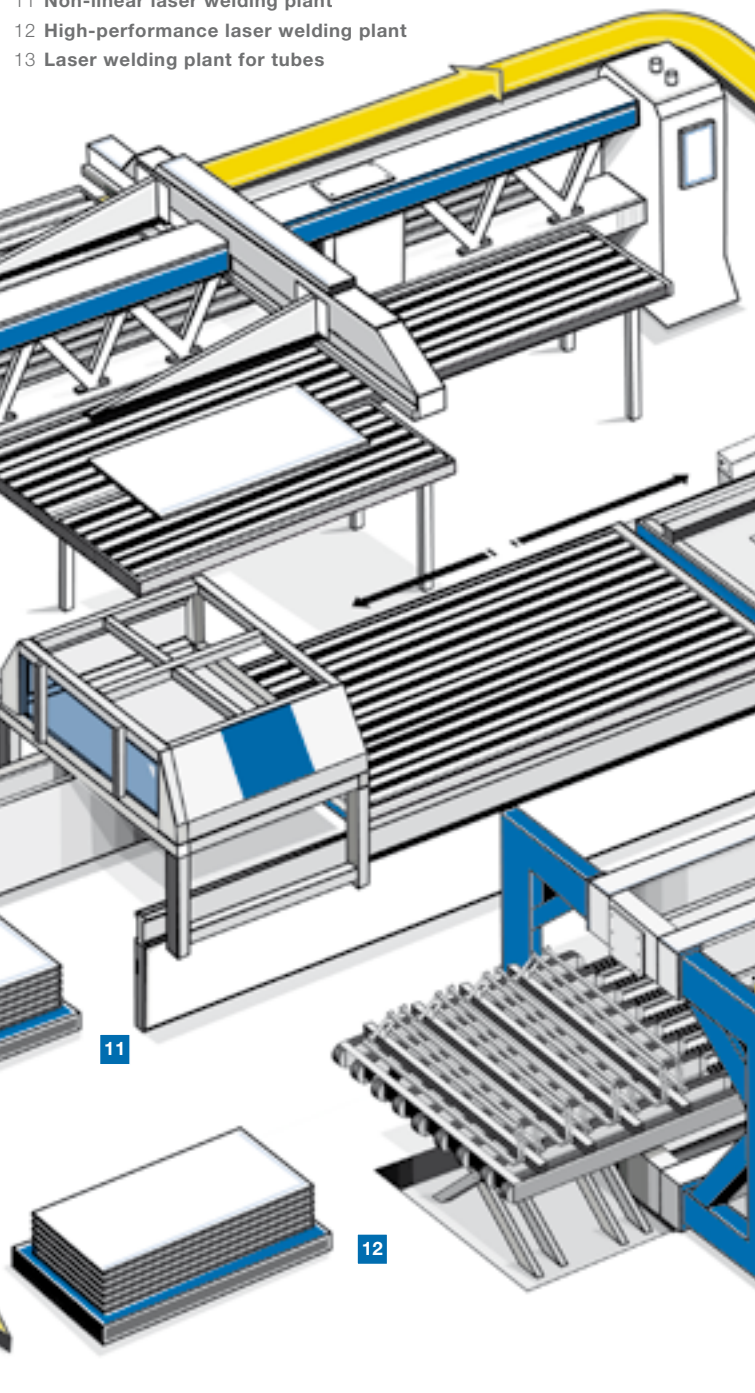

ANDRIL
Metals

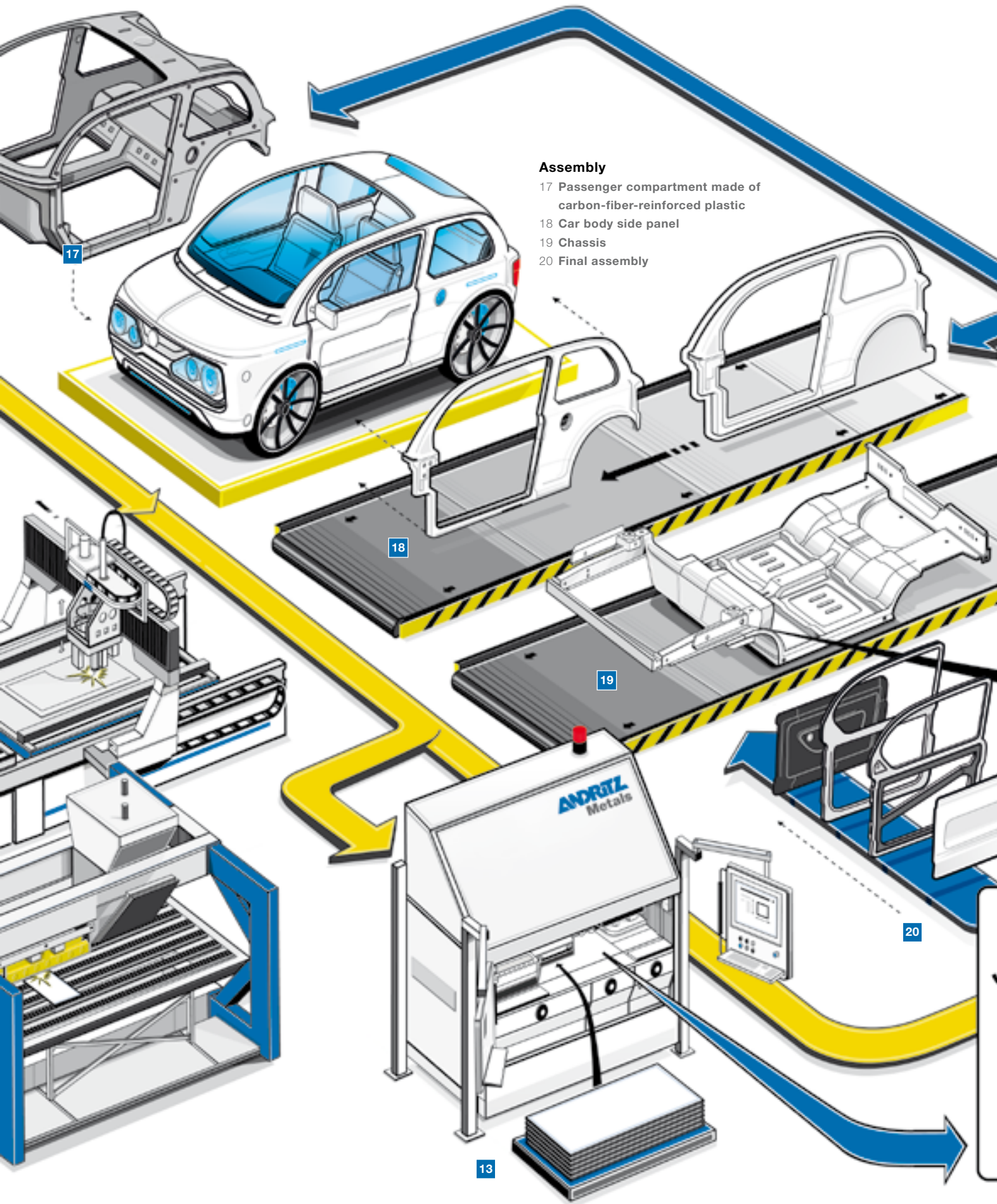

Assembly

- 17 Passenger compartment made of carbon-fiber-reinforced plastic
- 18 Car body side panel
- 19 Chassis
- 20 Final assembly

17

18

19

20

13

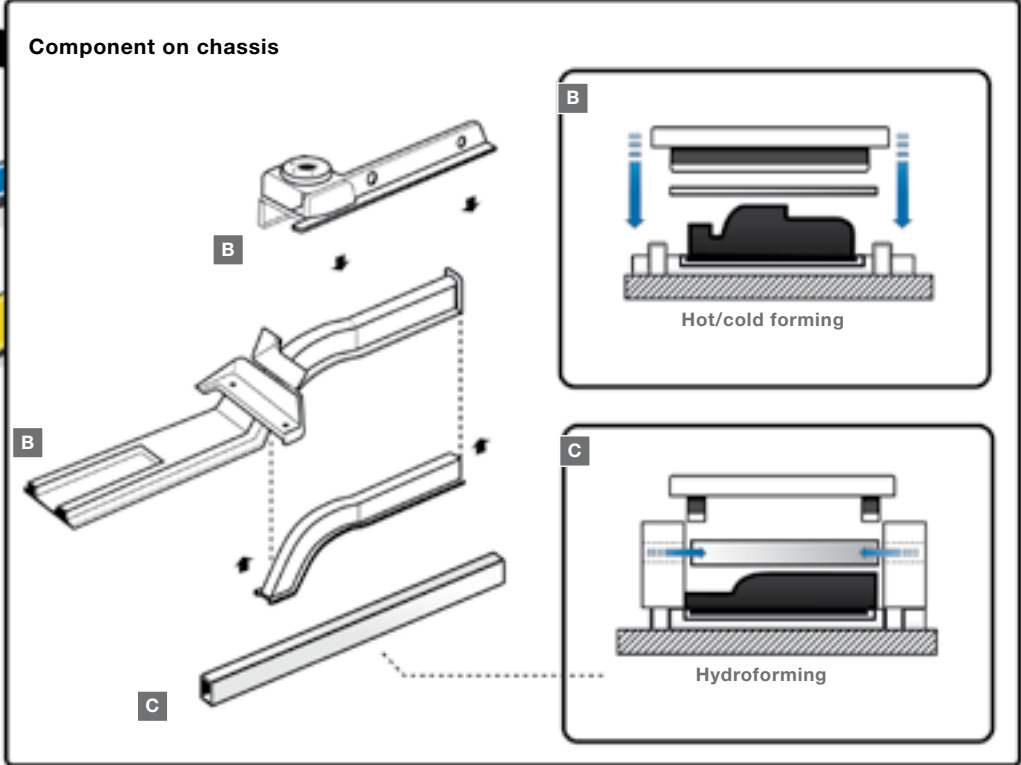
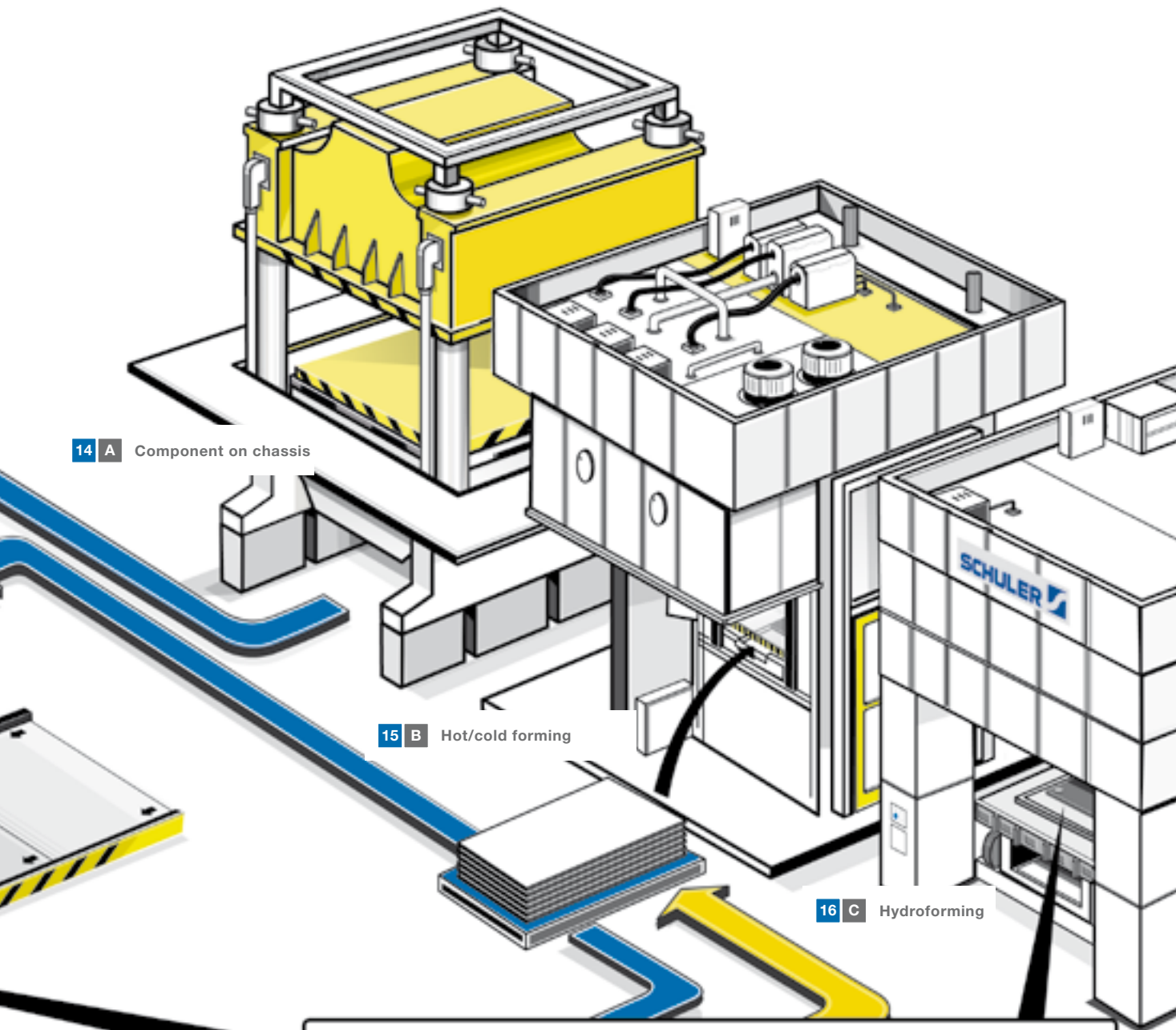

Highlights 2014



Europe

Schuler received the largest service order in the company's history from a premium car manufacturer in Germany. The order comprises mechanical overhaul of the main assemblies of a transfer suction press (69,000 kilonewtons press force), upgrade of the electrical equipment, and new automation equipment for the servo-loader. The plant will be used to produce exterior car body panels. Schuler will also supply four servo-tryout presses, which are used to test new tools, to a German premium car manufacturer. A European car manufacturer ordered three blanking lines with TwinServo technology for production locations in Germany and Mexico.

In Erfurt, Germany, Schuler started up a large new drilling machine. This drilling machine, with 300 milling tools, will bore and mill large components of up to 120 tons. The first automatic stacking plant for finished parts with integrated surface inspection during the process was handed over to a German premium car manufacturer. Another premium car manufacturer started up a tryout press with ServoDirect technology.

Schuler also concluded important product development projects in Germany. At its Gemmingen location, the company presented the fourth generation of crossbar robots, which transport up to 15 parts per minute. The

maximum output of the previous generation was only 12 parts per minute. Crossbar robots are used to move parts from one stage of a press line to the next. Schuler has entered into a strategic partnership with the Aachen Center for Integrative Lightweight Production in order to continue the development of press technology and production processes for modern lightweight materials.

Schuler presented the first linear hammer with servo-technology at RUD-Schöttler, Germany. Highest-precision forging is possible thanks to the patented drive system. The electronic control system automatically adjusts the energy input and number of necessary forging blows to the actual forging result after each blow until the preselected part thickness is achieved. As a result, the cycle times and the energy needed for forming are reduced.

With its Efficient Hydraulic Forming (EHF), Schuler has developed a new technology for hydraulic presses. Compared to conventional hydraulic presses, EHF yields

ThyssenKrupp Rasselstein, Germany, commissioned the business area to modernize a continuous annealing line for the production of carbon steel. The scope of supply comprises a new electrical package and operating concept, comprehensive safety features and equipment, as well as substantial renovations and extensions to the plant's mechanical and hydraulic equipment. Thanks to this modernization project, the plant speed will be increased and the terminal equipment optimized.



energy savings of up to 60%. The first forging press with EHF technology was started up successfully at Imbach & Cie, Switzerland.

ANDRITZ METALS will rebuild an annealing line including the cooling section of the floatation furnace at Constellium Singen, Germany.

The business area successfully started up a compact rinsing section for ThyssenKrupp Steel Europe. After modernization of the plant, the consumption of flushing water was reduced significantly.

In Austria, ANDRITZ is supplying a new walking beam furnace with a capacity of 185 tons per hour for the Donawitz plant of voestalpine Schienen. A plate stretcher for the production of high-grade aluminum plates for the aircraft and car industries was handed over to AMAG Rolling, Austria. ANDRITZ Soutec also received an order from voestalpine Europlatinen, Austria, to supply a laser welding line.

ANDRITZ will supply a 20-high precision rolling mill with a width of 1,550 millimeters and strip reduction of up to 70 micrometers to Arinox, Italy. The plant will be the largest precision rolling mill in the world.

The State Mint in Russia ordered seven vertical Schuler coin minting presses, which will produce circular and non-circular, as well as bimetallic coins. There were also three successful start-ups in Russia. Oil & Gas Systems in Sukhodol started up the largest hydraulic forging press built by Schuler to date. The press, which will be used to manufacture forged parts for pipeline fittings, has a press force of two times 140,000 kilonewtons and a height of 22 meters. One of the largest hydraulic presses to be manufactured so far by Schuler was delivered to ZSKB-Progress. The products manufactured on this triple-action press include filler caps made of aluminum for the Soyuz rockets. And in the record time of just eleven days, ANDRITZ METALS completed the rebuild of the process part of a continuous pickling line for carbon steel at OAO Severstal. This rebuild significantly enhanced the speed of the process.



North America

Schuler will supply a mechanical transfer press with a press force of 29,000 kilonewtons for a plant belonging to German automotive supplier LuK in the USA. The same type of press will also be supplied to a LuK plant in China. A hydraulic press hardening machine (press force 26,000 kilonewtons) was ordered by voestalpine for a plant in North America. This press will produce hot-formed structural components from galvanized material for cars. Schuler will supply 12 coin presses to the United States Mint, which will be used to mint penny, nickel, dime, quarter, and half-dollar coins.

ANDRITZ METALS received an order from Constellium and the joint venture Constellium/UACJ to supply two continuous annealing and pickling lines and two finishing lines for production sites in Neuf-Brisach, France, and

Bowling Green, Kentucky, USA. The annealing and pickling lines with floatation furnaces have an annual capacity of more than 100,000 tons each and are used to process body-in-white aluminum used in the automotive industry.

A customer in the USA ordered two annealing and passivation lines for the production of aluminum strip, each with an annual capacity of 170,000 tons. The scope of supply includes the complete mechanical and electrical equipment as well as all process parts.

ANDRITZ Soutec received an order from ArcelorMittal Tailored Blanks Americas, Canada, to supply two non-linear laser welding plants for welding particularly strong and light car body parts.

South America

Schuler will supply a mechanical press line with robot automation for a European car manufacturer's plant in South America. The scope of supply includes a lead press and four line presses (28,300 kilonewtons total press force).

Fiat, Brazil, ordered the delivery of a Schuler mechanical press line with robot automation. The scope of supply includes a lead press (press force: 12,000 kilonewtons) and four line presses with 8,000 and 6,300 kilonewtons press force.

Schuler recorded three important orders in Mexico. A leading Latin American producer of steel tubes ordered the supply of a spiral-weld tube plant. A blanking line will be supplied to the production location of a German steel manufacturer. And Metalsa ordered a mechanical transfer press with ServoDirect technology (press force: 16,000 kilonewtons).



Asia

A premium car manufacturer in China ordered a new six-stage press line with ServoDirect technology and a crossbar feeder, as well as a servo-tryout press from Schuler. The plant will be used to produce parts for new off-road vehicles and transporters. Other Chinese automobile manufacturers and automotive industry suppliers will take delivery of hydroforming presses to produce tubular shapes, as well as a blanking line, a 25,000-kilonewton transfer press, a press hardening machine, and an 80,000-kilonewton forging press. A German automobile manufacturer in the premium sector ordered a servo-press line (total press force: 103,000 kilonewtons) to manufacture car body parts for models with a long wheel base. Schuler is manufacturing and supplying press hardening dies to the Chinese market for the first time: a toolmaker and automotive industry supplier will manufacture 13 hot-formed components with five Schuler series production dies for two car models produced by a German-Chinese manufacturer. Schuler handed over one cutting line each to cut steel and aluminum blanks for subsequent forming to two automobile manufacturers in China. And erection of a new demonstration and reference



center started at the Schuler location in Tianjin. A new 16,000-kilonewton press with TwinServo technology will go into operation at this Servo TechCenter as from 2015.

The business area will supply a complete hot-dip galvanizing line with an annual capacity of 400,000 tons to Chinese steel producer Yieh Phui Technomaterial. The plant was designed to produce high-strength steel grade for the automotive industry. ANDRITZ Soutec received an order from Great Wall Motors, one of China's leading car manufacturers, to supply another laser welding plant. Two linear laser welding plants each will be supplied to Anshan Steel and Shanghai Baosteel.

Great Dynasty, Hong Kong, ordered a tension-leveling line for cold-rolled aluminum strip with an annual capacity of 80,000 tons, and Rizhao Steel Holding Group, China, placed an order for the supply of a pickling and galvanizing line for hot-rolled steel strip with an annual capacity of 700,000 tons.

Schuler is to supply a complete tube rolling mill to Group Five Pipe Saudi, Saudi Arabia. The scope of supply comprises an offline spiral-weld tube plant, which can produce tubes with diameters between 508 and 2,235 millimeters and a length of 12 to 24.4 meters, as well as four welding stands and inspection stations.

Another customer in Asia ordered the delivery of a Schuler press to manufacture lids for beverage cans. The plant will produce more than 3,000 lids per minute.

Walsin Lihwa, Taiwan, commissioned the business area to supply a tension-leveling line, a rolling mill, and a regeneration plant for the stainless steel cold-rolling mill in Taichung.

Three successful start-ups were also reported from Asia. The continuous annealing and pickling line for cold-rolled strip with an annual capacity of 160,000 tons supplied to Bahru Stainless, Malaysia, as well as the cold-rolling mill, the continuous annealing and pickling line for hot- and cold-rolled stainless steel with an annual capacity of 350,000 tons and the strip processing line for hot-rolled strip supplied to Walsin Lihwa, Taiwan, were started up successfully. A modernized galvanizing line (annual capacity: 200,000 tons) was handed over successfully to Synn Industrial, also in Taiwan.

Large order for Schuler from FAW Volkswagen Automotive, China

One of the largest orders in Schuler's 175-year history was received from FAW Volkswagen Automotive, China. The order comprises three press lines with ServoDirect technology (see photo) and three presses for die tryout, all for production locations in China. The servo-press lines are used mainly to produce car body parts, such as hoods or doors. The presses are particularly powerful: compared to the conventional mechanical press lines used to date, productivity can be increased by approximately 20% and energy consumption reduced at the same time.







Profile

ANDRITZ SEPARATION is one of the leading global suppliers of technologies and services in the solid/liquid separation sector, as well as for the production of animal feed and biomass pellets. The comprehensive product portfolio for solid/liquid separation comprises centrifuges, filters and drying plants, screens, thickeners, separators, and transportation systems – the industries served include municipal and industrial wastewater treatment, chemicals, food and beverages, as well as mining and minerals. The service sector focuses on plant modernization, spare and wear parts, and process optimization.



Market development 2014

Investment and project activity for solid/liquid separation equipment saw mixed development in the industries served by ANDRITZ during 2014. While demand in the municipal/industrial waste water treatment sector as well as in the food and chemical industries was solid, investment activity in the mining industry continued to be low.

Project activity in the animal feed industry was good – both for mill expansion projects and new greenfield plants. The biomass pelleting segment noted solid project activity.

23,100 cubic meters of sewage are processed every day at the Jennersdorf sewage treatment plant, Austria. ANDRITZ SEPARATION supplied a belt thickener and a centrifuge for dewatering of sewage sludge. The dewatered sludge is used in agriculture, for example as fertilizer or compost.



Market data

2.9 billion euros for a clean environment

Growing environmental awareness, increasingly tough environmental legislation, and the rising world population are important driving forces in the market for municipal sludge treatment. Improvements in the treatment of wastewater have led to larger volumes of sludge that need processing. This involves thickening, dewatering, and drying and ANDRITZ SEPARATION is among the global market leaders in these areas. The largest markets for thickening, dewatering, and drying equipment are currently Europe and China.

Market volume for municipal sludge treatment equipment by region*

In 2014, the market volume amounted to approximately 2.9 billion euros

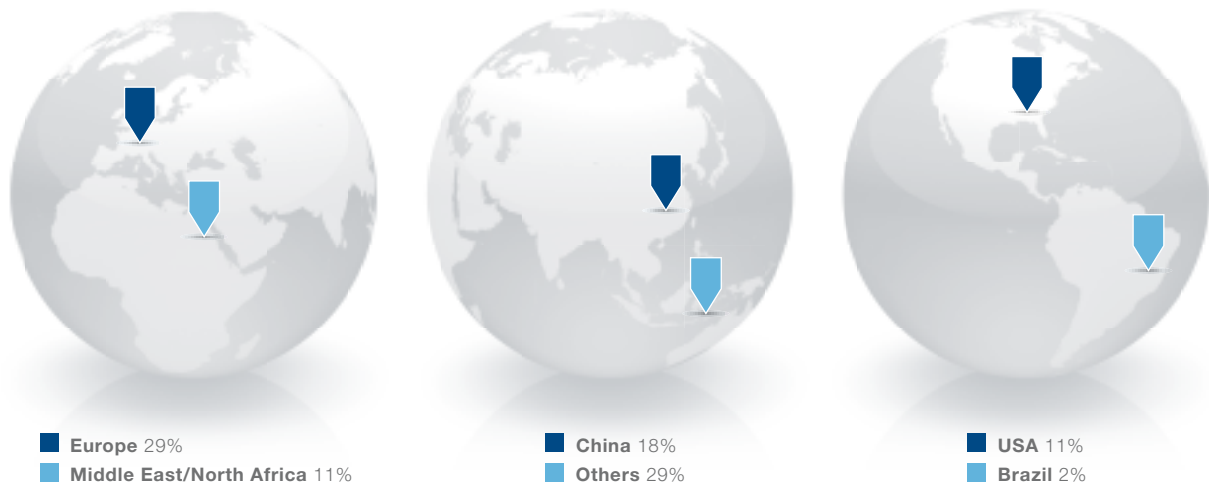

Experts are expecting the market volume for municipal sludge treatment to increase to around 3.9 billion euros by 2017, which means an average annual growth rate of 4.7% – the largest growth markets being Brazil, the Middle East, North Africa, and China.

Average growth rate 2014-2017 by region

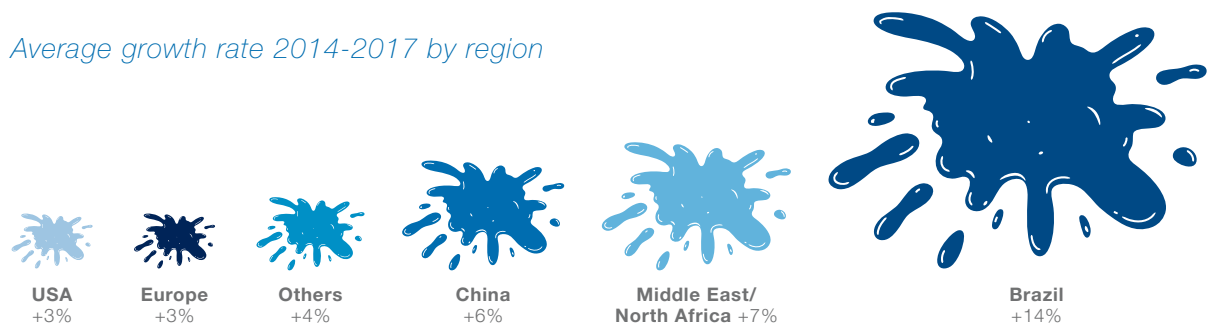

* Thickening, dewatering, and drying equipment
Source: GWI

Model of a phosphoric acid molecule: ANDRITZ filters extract phosphoric acid from calcium sulfate. Phosphoric acid is essential to the survival of all biological organisms and used in agricultural fertilizers.

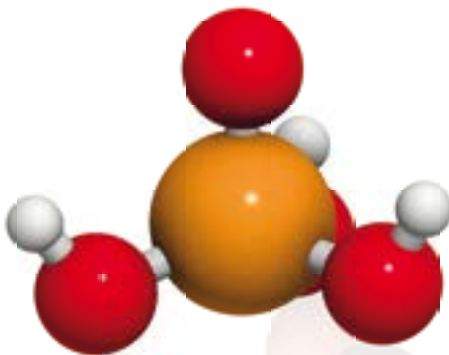

Successfully linking Asia, the USA, and Europe

The challenge:
global competition

The customer had high expectations: the most advanced technology at the lowest possible price! Despite tough competition, ANDRITZ succeeded in winning an important contract to supply filter systems for the fertilizer industry in Indonesia. The cooperation between ANDRITZ experts in Asia, Europe, and the USA ensured that the customer's expectations were met.

July 2014. After only a four-month construction period, the time had arrived to install the phosphoric acid filtration section of a new fertilizer plant belonging to the Petrokimia Group in Gresik, a town on Surabaya, Indonesia's main island. The section consists of two tilting pan filters supplied by ANDRITZ SEPARATION, 18 and 24 meters in diameter. Each filter is almost three times the size of a tennis court. The filters extract phosphoric acid from calcium sulfate, a by-product of the reaction of phosphate rock and sulfuric acid. Phosphoric acid is essential to the survival of all biological organisms and is used in agricultural fertilizers.

Back in 2011, Patricia Poh and Matthias Zick, Sales Manager and Managing Director of ANDRITZ Singapore, discovered that Petrokimia was intending to modernize the filter systems at its plant in Gresik, which had been in operation since 1983. Matthias Zick is a process engineer and already has extensive experience of working in this field in Germany and Malaysia. At that time, he had been living in Singapore for five years, where 55 ANDRITZ employees support the Indian and Southeast Asian market. Zick and Patricia Poh, who comes from Singapore, know the market well and they were aware that this contract represented a major opportunity for ANDRITZ. However, the most recent filter upgrade project at Petrokimia took place more than 15 years earlier, so the company had little or no experience with ANDRITZ.

A different approach to problems in Asia

Patricia Poh made contact with Petrokimia and flew to Gresik to introduce ANDRITZ. "That was the start of a whole series of meetings which allowed us to gain the confidence of the managers and to explain the benefits of our technology." It was also important to find out in detail about the customer's requirements. But in Asia, in particular, this is not always an easy thing to do. The process can be quite different from that in the West, for example. Most Asian business people will simply dismiss questions about the problems that need to be resolved, because in many Asian cultures no one talks about difficulties. "To really get to the heart of the matter, you have to develop a close and honest relationship with customers, so that you can win their confidence," says Poh.

In the meantime, Patricia Poh had put the ANDRITZ internal network for international projects into action and had informed her colleague John Madden in Arlington, Texas, USA. Together with the Sales Manager from the USA, Vic Norton, and the Process Engineer Farooq Ellahi, who was born in Canada, they formed the international project team. "We worked closely with Singapore right from the beginning," says Madden, who has been with ANDRITZ since 1978. "This allowed us to tailor our bid to meet the customer's specific requirements."

In 2012, Petrokimia put the project out to tender. The contract to build the entire plant, which had a value of

“要取得成功，

必须与客户建立密切的关系。

更为重要的是，

要以诚待人。

惟有如此，才能获得客户对我们技术的认可与信任。”



Patricia Poh, Sales Manager at ANDRITZ Singapore:
“To be successful, you have to develop a close relationship with customers and, most importantly, be honest with them. This is the only way to build their trust and their confidence in our technologies.”

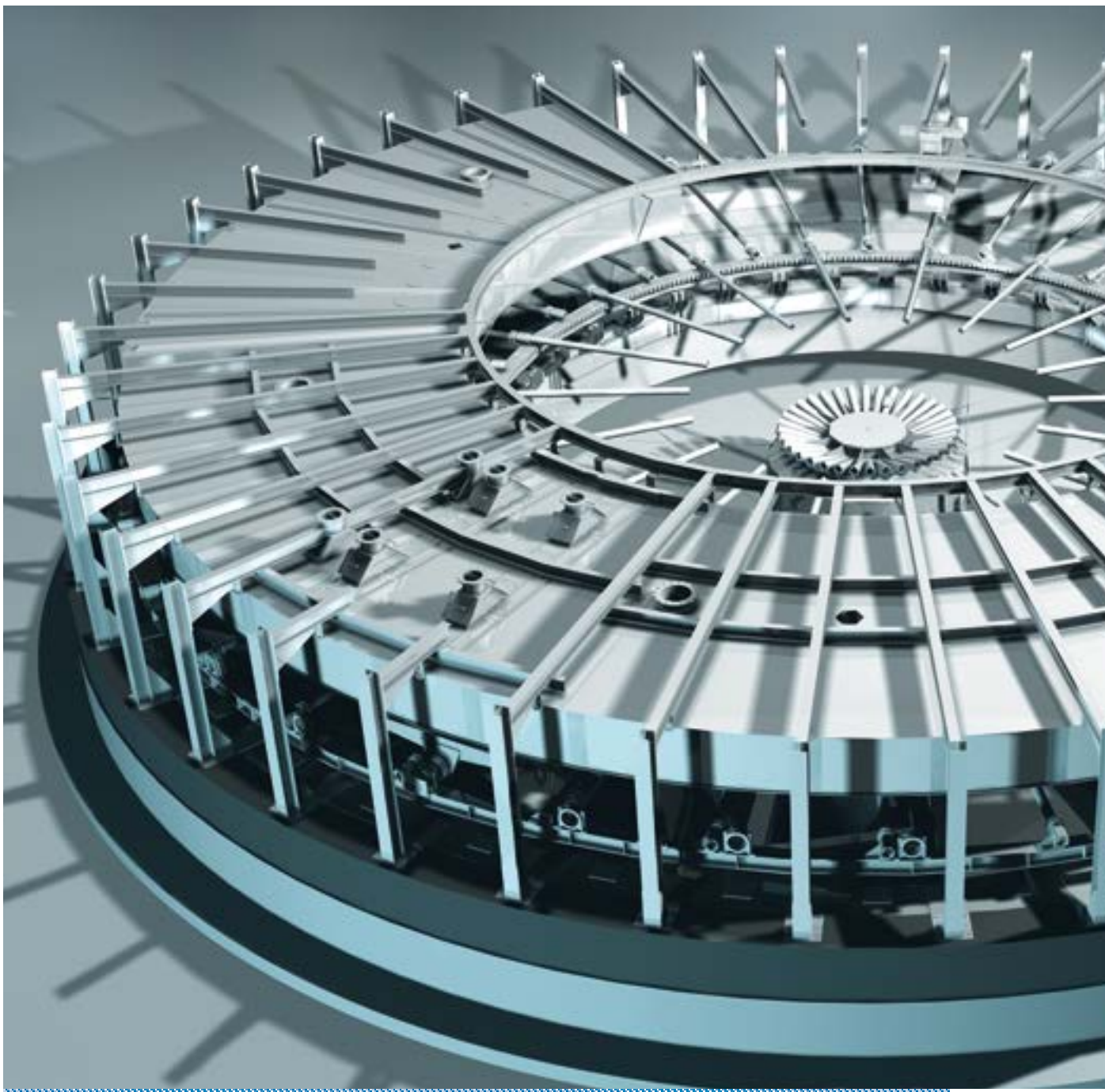

Giant filter systems

ANDRITZ SEPARATION has been supplying tilting pan filters for more than 50 years and has delivered more than 300 systems throughout the world. Tilting pan filters are rotating filter systems used in continuous production processes with a high throughput to separate coarse-grained solids from liquids. They are mainly found in the bauxite and phosphate processing industries and in fertilizer manufacturing. Separating, washing, and removing the moisture from the solids in the tilting pan filter have a decisive influence on the quality of the end product and on the cost-effectiveness and environmental friendliness of the production process. Large systems often have a filter area of more than 230 square meters and weigh more than 150 tons in total.



about 140 million euros, was awarded to the Chinese and Indonesian joint venture Wuhuan Engineering/Rekayasa Industri. The general contractor had its own contacts in its home country of China and Chinese companies have long since been in a position to manufacture tilting pan filters. But this is where the relationship of trust built up with the end customer Petrokimia came into play. All the meetings and the hard work paid off and ANDRITZ was awarded the

contract to supply the two tilting pan filters, in the face of tough competition in particular from China.

What was the decisive factor in winning the contract? “The quality of our technologies, the attractive price-performance ratio, and most importantly our proximity to the customer,” says Matthias Zick. “Other factors included our experienced employees, who understand process engineering and can deliver high-quality products, service provided from Singapore, which is not far away, knowledge of the language, the same time zone, complete familiarity with the customer’s requirements, and last but not least a good price.” Sales Manager Patricia Poh emphasizes the success of the transcontinental project implementation process: “While the team in Singapore convinced both Petrokimia and Wuhuan Engineering/Rekayasa Industri of the technical superiority of our filters, the team in the USA ensured that we were able to respond to our competitors’ price proposals. And in the ANDRITZ headquarters in Austria, our colleagues worked on all the details of the contract.”

Different cultures and languages

On international projects of this size, comprehension problems and cultural differences are almost inevitable, according to Zick: “During the implementation process, we had to bring together three cultures and three languages. The Indonesians spoke no Chinese and the Chinese people could only manage a few words of English. The city state of Singapore is the interface between these two cultures. The official language is English, but the majority of the residents speak Mandarin. Our colleagues from the Singapore office translated for the team in the USA and passed information between the Indonesian end customer and the Chinese/Indonesian general contractor.”

In April 2014, the components for the ANDRITZ 30-EH hemihydrate filter and the ANDRITZ 24-125 dihydrate filter were delivered to Indonesia from the USA. A total of 30 containers weighing more than 200 tons arrived on the construction site in Gresik. The central valve for the filter system alone weighed 10 tons. There were also 24 smaller and 30 larger highly polished filter cells. Before the assembly work could start, the parts had to be counted and registered. Even that was more difficult than it sounds. “Of course, the specification is in the contract,” says Zick. “But every party to the contract interprets things slightly differently. This means that it’s important for us to talk to one another and find compromises.” The process of assembling the filters took three months. Finally, they were raised to a height of 25 meters by cranes, before being installed and successfully started up in July 2014.

All the hard work had been well worthwhile. The customer was very pleased with the filters and this important reference site for ANDRITZ immediately led to another contract, involving the supply of six tilting pan filters to a customer in Saudi Arabia.

Philipp Mattheis, Singapore

An aerial photograph of terraced rice fields. The terraces are arranged in a series of curved, step-like patterns. The water in the terraces is a milky, brownish-white color. In the middle ground, one of the terraces is filled with vibrant green rice plants. The overall scene is a mix of brown, white, and green, showing the intricate geometry of the agricultural landscape.

Phosphorus – the elixir of life

Phosphorus is essential to all living creatures and plays a crucial role in the development and functioning of organisms, for example in DNA and the cellular energy supply. Phosphorus was formed many millions of years ago in a similar way to oil, when the remains of plankton and animals were deposited on the seabed. In addition, phosphorus cannot be manufactured artificially. Plants need phosphorus for their structures, but also to form seeds and fruits. The availability of phosphorus is a factor that can limit the growth of plants in many cases, which is why large quantities of phosphorus-based fertilizer are used in the agricultural industry. Alongside nitrogen, phosphorus is the most important component of fertilizer. The oxygen compounds of phosphorus, known as phosphates, are obtained from minerals such as apatite. The main deposits can be found in North Africa, the Middle East, and Asia. A complex chemical process is used to extract and concentrate phosphoric acid from a mixture of rock and liquid.



Highlights 2014



Europe

A salt producer in Belarus ordered a fluidized bed system to replace the existing rotary dryer system. This new, state-of-the-art dryer system achieves high product quality and energy savings by integrating waste heat into the process.

An energy producer in Poland awarded the business area an order to supply four centrifuges for a flue gas desulfurization system in order to reduce air pollution and meet environmental requirements.

One of the major potash producers in Russia ordered vacuum belt filters and disc filters.

Steam peelers for a high-quality vegetable and fruit processing line will be supplied to a major food producer in the United Kingdom.

Several European customers ordered equipment to be used in petrochemical and polymer applications, including tilting pan filters, rotary dryers, pressure drum filters, and fluidized bed systems; orders for this equipment also came from customers in Asia and the USA.

Orders for biomass mills were secured by the business area worldwide, including an order from a European customer for a mill with an hourly production capacity of twelve tons of wood pellets.

A new feed pelleting plant with a production capacity of 60 tons per hour will be supplied to an animal feed producer in Eastern Europe. Another Eastern European feed producer ordered the entire process equipment for a new multiple-line feed mill. Several orders were booked for mid- and high-capacity pelleting lines, replacing smaller or outdated lines in animal feed plants in Western Europe.

In the aqua feed and pet food segments, orders for the supply of new extrusion process lines were awarded in both Western and Eastern Europe.

North America

In the municipal waste water treatment segment, the business area received important orders in the USA: three high-performance decanter centrifuges will be delivered to a large city in Texas, and a belt drying system to a large city in Missouri. Also in the USA, customers in the food industry ordered the supply of drying equipment, including a drum dryer to produce modified starch. Four centrifuges will be delivered to a mineral handling plant. The centrifuges will help to reduce the plant's operating costs and increase its production reliability.

To achieve better consistency and quality of the end product, a Canadian customer ordered a paddle dryer to treat oil sands. This is the first time worldwide that an ANDRITZ paddle dryer will be used in this kind of application.

Several orders for milling and pelleting expansion projects were secured from (second generation) biomass fuel producers in North America.



South America

A water utility in Brazil awarded the business area an order to rebuild and repair its existing filter presses. Other orders from South America included the supply of new feed process lines and of filter presses for the production of biodiesel.



Innovation #1: new screw press to reduce water consumption by 30%



For the waste water treatment plant, industrial effluent treatment plant, and food application segments, the business area launched a new sludge dewatering machine: the ANDRITZ C-Press is a screw press providing high performance and combining compact design with low operating costs. In addition to a long lifecycle, the press also offers easy operation, low maintenance, and – due to bi-sequential cleaning – 30% less water consumption than comparable equipment. The new C-press complies with all European Union regulations on such issues as safety, hygiene, and environmental protection.

Innovation #2: new belt press to lower investment costs and maintenance work

The business area presented a new, innovative belt press for dewatering in municipal and industrial applications, based on a new low-profile design and flexible modular construction. The main benefit of the new belt press is that size and weight were reduced by around 50% each compared to the previous machine generation. As a result, investment costs and maintenance work were reduced, while still achieving the same machine performance.



Asia

In China, the business area recorded a number of important orders from various industries. Two automatic filter presses will be delivered to the waste water treatment plant of a large city in the western part of the country. Zhanjiang Chenming Pulp & Paper ordered one of the largest biomass belt dryers in the world for its biomass gasification project. In the mining and mineral industries, three side-bar filter presses were ordered for the production of molybdenum, which is used to increase the rigidity of steel and metals. Two ANDRITZ SEPARATION hyperbaric disc filters will be delivered to a customer in the coal industry. The business area also received an order to supply two decanters and one vacuum disc filter for a customer in the chemical industry. Other Chinese customers will take delivery of gypsum centrifuges for flue gas desulfurization and separators to be used in the tea clarification process. Several orders for high-capacity aqua feed extrusion lines were secured from major Chinese aqua farming companies – among these was an order for the delivery of a new marine aqua feed processing plant.

A paddle dryer will be delivered for a sludge and waste incineration plant in South Korea. The dryer should enhance plant performance and reduce energy consumption.

Customers in the food industry in Asia ordered drum drying systems. Five side-bar filter presses for vegetable oil production will be delivered to a customer in Indonesia.

The business area received an order to supply decanter centrifuges from a Spanish contractor acting on behalf of a customer in Saudi Arabia that produces POM (polyoxymethylene). Another Saudi Arabian customer in the chemicals sector ordered six tilting pan filters and six thickeners to remove fine solids from sedimentation circuits in a phosphoric acid plant.

In Thailand, ANDRITZ SEPARATION will replace several existing centrifuges with eight horizontal peeler centrifuges for starch production. The new centrifuges are fully automated and will assure a stable moisture level.

In the animal feed sector, orders included the supply of a new dairy feed processing plant to the largest Indian dairy group and of a poultry feed pelleting plant, also in India. Several other Asian customers ordered process lines for the production of aquatic feed pellets and biomass pellets.

www.ANDRITZ.com





If you want to find out more about the ANDRITZ GROUP, simply visit www.andritz.com. On our website, you can find all important information on ANDRITZ and its business areas, our entire range of products and services, current news on major orders, acquisitions, and financial results, details of all the ANDRITZ locations worldwide, as well as our annual report and annual financial report.

Financial calendar 2015



Imprint

Published by

ANDRITZ AG
8045 Graz, Austria

Concept and editing

ANDRITZ AG

G+J Corporate Editors GmbH
20459 Hamburg, Germany

Graphic design

Faschingbauer & Schaar Werbeagentur GmbH
8010 Graz, Austria

Photos

ANDRITZ, ArcelorMittal, Werner Beitel, Wolfgang Croce, Eldorado Brasil, Yannick Le Gal, Werner Krug, Peter Melbinger/Elisabeth Paulitsch, MeyGen, Theun-Hinboun Power Company, ThyssenKrupp, Shutterstock, Zellstoff Pöls

Printed by

Steiermärkische Landesdruckerei GmbH
8020 Graz, Austria

ClimatePartner^o
climate neutral

Print | ID: 10911-1502-1008



Disclaimer

Certain statements contained in the annual report 2014 and in the annual financial report 2014 constitute forward-looking statements. These statements, which contain the words "believe," "intend," "expect," and words of a similar meaning, reflect the Executive Board's beliefs and expectations and are subject to risks and uncertainties that may cause actual results to differ materially. As a result, readers are cautioned not to place undue reliance on such forward-looking statements. The company disclaims any obligation to publicly announce the result of any revisions to the forward-looking statements made herein, except where it would be required to do so under applicable law. The annual report 2014 and the annual financial report 2014 contain assumptions and forecasts which were based on the information available up to the copy deadline on February 25, 2015. If the premises for these assumptions and forecasts do not occur, or risks indicated in the chapter "Corporate risks" and in the management report in the annual financial report 2014 do arise, actual results may vary from the forecasts made in the annual report 2014 and in the annual financial report 2014. Although the greatest caution was exercised in preparing data, all information related to the future is provided without guarantee.

ANDRITZ